



Instruction Manual
for
Graduate 150
Scholar 175
Master 200

Unihoist Ltd Electric and Hydraulic illustrations 2 - 3

Introduction 4

Assembly and commissioning instructions 5 - 6

Safety precautions 7

Electric hoist controls illustration 8

Operating instructions 9 - 10

Charging instructions 11-12

Maintenance schedule & Daily check list 13-15

Technical Specifications 16-17

Slings for use with the Unihoist 18

Sling chart 19

Sizing and Washing Instructions 20

Instruction guide for the Easifit Sling 21 - 23

Instruction guide for the Easifit Deluxe Sling 24 - 26

Instruction guide for the Trinity Toileting Sling 27 - 28

Instruction guide for the Deluxe Hammock Sling 29 - 30

Trouble Shooting Guide 31

Servicing, Repairs, Inspections and Testing 32

KEY SYMBOLS:

The following symbols are used on the hoist:



ATTENTION, consult accompanying documents.



For indoor use only.



Class II - double insulated



Electric Shock Protection Type B



WEEE Regulations.

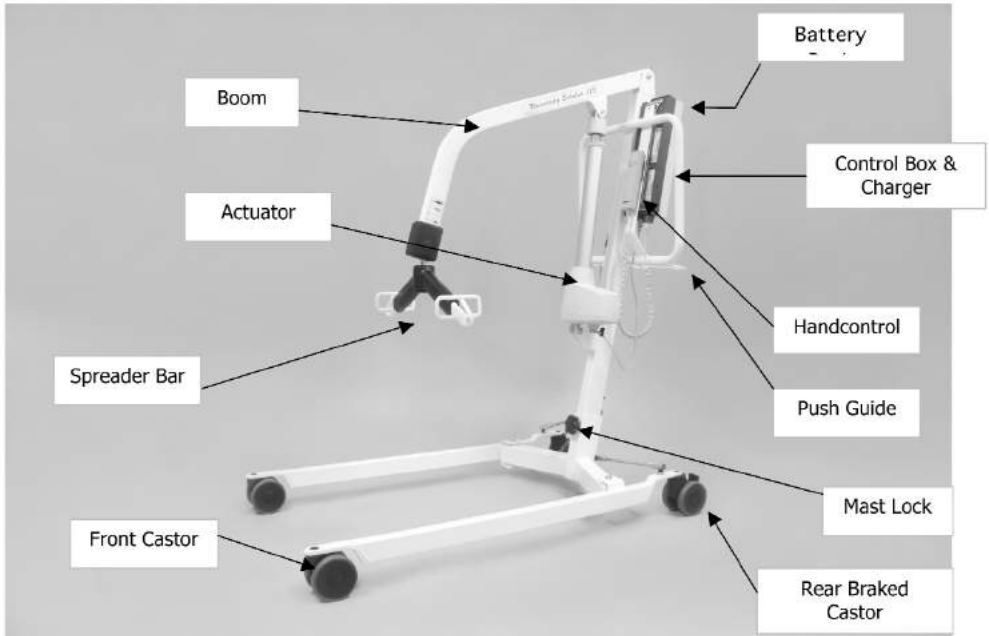

Electric Hoist





The Unihoist range of mobile lifts are available in both hydraulic and electrical versions. This manual covers both versions.

A Unihoist will arrive partially dismantled. It has been fully assembled and load tested at the factory and is supplied with a certificate of testing.

Documents relating to the lift are supplied in a wallet packed with each lift. They should be kept for future reference.

Documents:

- **Test Certificate**
- **User Manual**
- **Dealer Guarantee Card**
- **Customer Satisfaction Card**

The TEST CERTIFICATE is an important document and is valid for six months. When the certificate has expired it can be renewed after a satisfactory thorough examination and test carried out by a competent person. Servicing and periodic testing can be carried out by your supplier.

The Unihoist Graduate 150, Scholar 175 and Master 200 are suitable for the following CATEGORIES of lift within the working parameters of the lifts specified in the TECHNICAL SPECIFICATIONS.

- Category A – Wheelchair
- Category B – Bed
- Category C – Bath
- Category D – Toilet/Shower
- Category E – Floor
- Category F - 90° Rotation

The Unihoist range is suitable for patients in the SITTING, SITTING/RECUMBENT and RECUMBENT positions.

The Unihoist range carries the CE mark and complies with the following EC directives:

INTENDED USE

The University Graduate 150, Scholar 175 and Master 200 are for patient lifting. DO NOT use them, or allow them to be used, for any other purpose.

All patients lifted with these hoists should be assessed for suitability by trained, professional staff and be attended by a carer during use.

The University Graduate 150, Scholar 175 and Master 200 are used in conjunction with a range of slings, sized to suit patients of varying builds.

The hoist can be used for lifting from the floor, wheelchair, chairs, bed and toilet.

Whilst these hoists are capable of transporting patients from room to room, it is recommended other transportation methods are used in order to minimize the patient's time in the sling.

We do not supply or fit any Weigh Scales on our hoist.

The Master 200 should not be moved with the patient in the highest position.

Only use the hoist on a flat surface and never attempt a lift on a slope.

Medical Device Directive (93/42/EEC)
EMC Directive (89/336/EEC)



CE Mark on this product demonstrates conformity with the Medical Devices Directive (93/42/EEC)

Assembly and Commissioning Instructions

The packing carton contains:

- Wheeled base
- Mast and boom assembly
- Leg opening handle
- Document Wallet
- Handcontrol (electric version only)
- Battery charger/control box (electric version only)
- Battery pack (electric version only)
- Charging cable (electric version only)

1. Remove all the parts from the carton and place on the floor, taking care to protect the finish from damage.

SAFETY NOTE: Some of the parts are heavy and will need to be lifted with care. Heavier assemblies may require two people to lift.

2. Apply the brakes on the rear castors of the base
3. Fit the mast to the base. The mast fits into a rectangular hole in the top of the base.

SAFETY NOTE: Possible finger trap. Keep fingers away from the end of the mast when fitting to the base.

4. When the mast is fully engaged with the base, fit & fully tighten the mast locking knob.

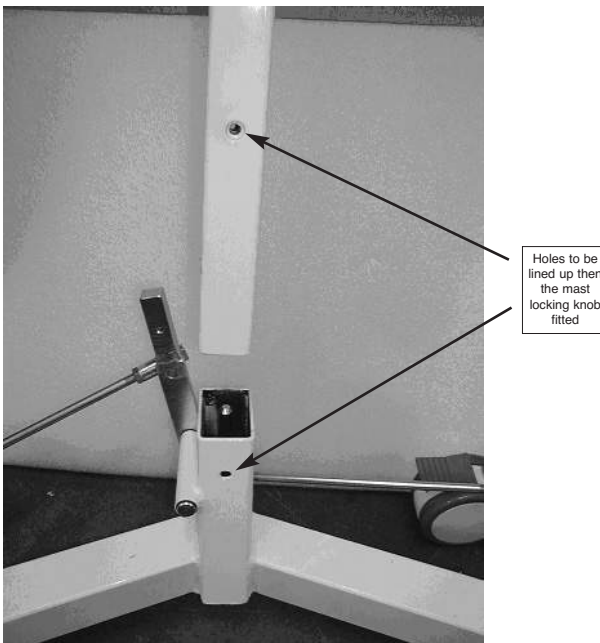

5. Remove the screw from the leg opening lever located at the rear of the chassis. Fit the leg opening handle through the gate on the mast and push the open end over the leg opening lever. Retain the handle with the screw removed earlier from the leg opening lever.
6. Check the legs of the lift open and close satisfactorily.

Electric Hoists only

7. Check the RED emergency stop button located on the controller is in off (out) position.
8. Fit the handcontrol to the handcontrol socket located at the base of the power pack.

Important

The handcontrol plug is indexed and can only be fitted one way. Make sure the plug of the handcontrol is firmly pushed into the socket. **Do Not Force**

9. Fit the battery pack to the control box as illustrated on page 8, making sure that it clicks into position.
10. Plug the actuator jack plug into the actuator socket located at the base of the Control Box. The indicator label will identify the correct socket.
11. Push the up and down buttons on the hand control and confirm the boom rises and lowers. The lift is now ready for use.

Hydraulic models only

7. Close the hydraulic unit release valve by turning the knurled aluminium knob on the unit fully clockwise.

Note:

The release valve requires only minimal tightening to operate and should only be closed finger tight. **DO NOT** apply excessive force to the valve knob as this will result in damage to the valve.

8. Pump the handle of the hydraulic unit and confirm the ram raises the boom.
9. Open the release valve fully anticlockwise and check the boom descends. An unloaded boom will not come down under its own weight, it will be necessary to apply some pressure to the boom before it will descend.

Note:

The release valve is fully open and encounters a positive end stop in less than two full turns of the knob. **DO NOT** force the valve past the end stop as this will result in damage to the valve.

10. Close the release valve. The lift is now ready for use.

Please read and follow the safety precautions listed below. The operation and the use of the Unihoist patient lift is straightforward. These basic safety precautions will help make lifting operations easy and trouble free.

- **ALWAYS** carry out the risk assessment and plan your lifting operations before commencing.
- **ALWAYS** carry out the DAILY CHECK LIST before using the hoist.
- **ALWAYS** read this manual and familiarise yourself with the operating control and safety features of a hoist before lifting a patient.
- **DO NOT** use a sling unless it is recommended for use with the hoist.
- **ALWAYS** check the sling is suitable for the particular patient and is of the correct size and capacity.
- **NEVER** use a sling which is frayed or damaged.
- **ALWAYS** fit the sling according to the instructions in the user manual.
- **ALWAYS** check the safe working load of the hoist is suitable for the weight of the patient.
- **ALWAYS** carry out lifting according to the instructions in the user manual.
- **NEVER** disconnect or bypass a control or safety feature because it seems easier to operate the hoist.
- **NEVER** force an operating or safety control. Forcing will only strain or damage the hoist and may compromise safety.
- **DO NOT** lift a patient with the castor brakes on.
- **DO NOT** attempt to manoeuvre the hoist by pushing on the mast, boom or patient.
- **ALWAYS** manoeuvre the hoist with the handle provided. It is recommended that the hoist is pushed with the patient in front.
- **ALWAYS** lower the patient to the lowest comfortable position before transfers.
- **DO NOT** push a loaded hoist at speeds which exceed a slow walking pace.
- **DO NOT** push the hoist over uneven or rough ground, particularly if loaded.
- **DO NOT** attempt to push or pull a loaded hoist over a floor obstruction which the castors are unable to ride over easily.
- **DO NOT** bump the hoist down steps; loaded or unloaded, this will damage the castors.
- **DO NOT** attempt to negotiate a loaded hoist on a slope.
- **ALWAYS** apply the brakes when parking a hoist.
- **NEVER** use electric hoists in a shower.
- **NEVER** charge an electric hoist in a bathroom or shower room.
- **YOUR** hoist is for patient lifting. **DO NOT** use it, or allow it to be used, for any other purpose.
- **ALWAYS** ensure mast locking knob is in position before lifting a patient.
- **ALWAYS** use the hoist on a flat and level floor.
- **FOLLOW** a regular charging routine to prolong the life of the battery.

Control Box , Battery Pack and Hand control (Pre July 2012)

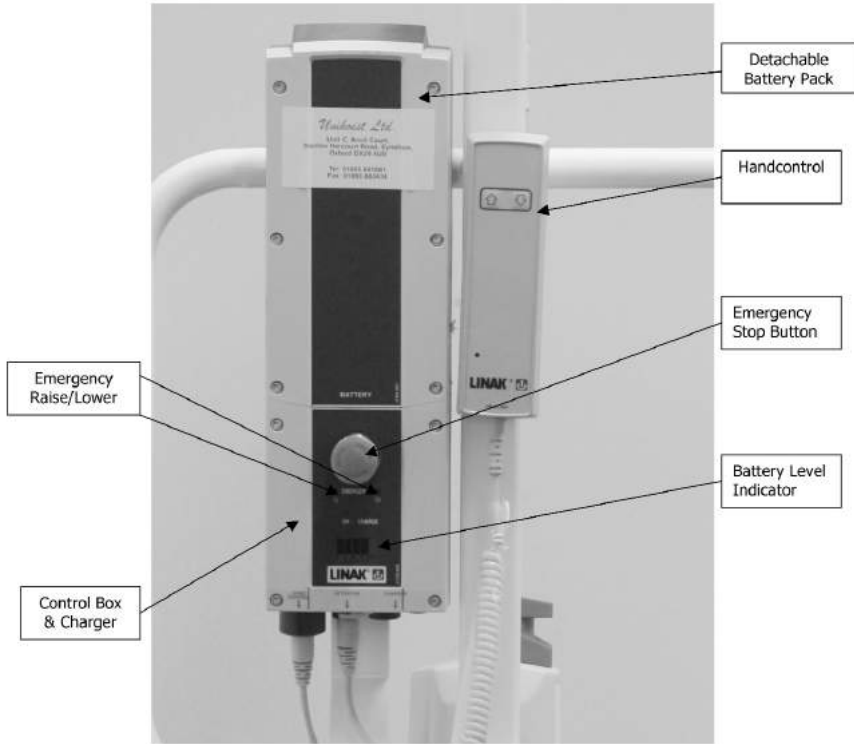

Control Box and Hand control (after July 2012)

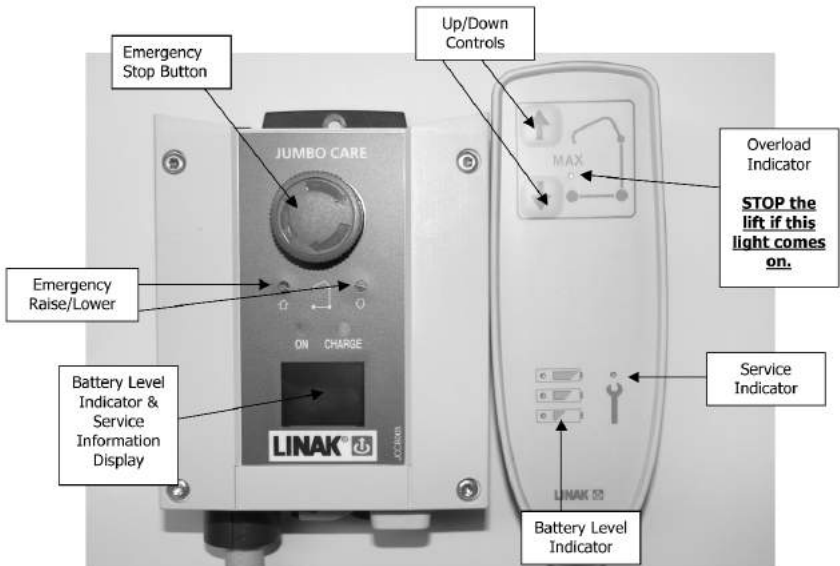

1. **Leg adjustment.** The legs on a Unihoist lift can be opened for access around armchairs and wheelchairs etc. For transferring and negotiating narrow doorways and passages the legs should be in the closed position. The leg opening mechanism is located at the rear of the lift and leg adjustment is achieved by moving the leg opening handle to the left for open and the right for closed. It is easier to make the leg adjustment when the lift is moving.
2. **Castors and Braking.** The Unihoist lift is provided with two braked castors at the rear of the base. The brakes should only be applied when the lift is parked. The brakes should always be released when a lifting operation is taking place. With the brakes released the lift will be able to move to the centre of gravity of the lift and prevent the client from swinging when completely lifted. Swinging can prove disconcerting and uncomfortable and may even cause injury.
3. **Raising and lowering the boom.** The boom is raised and lowered by a powerful electric actuator controlled by a simple handcontrol unit. The handcontrol has two buttons with directional arrows UP and DOWN. The actuator will stop automatically at the limit of travel in both directions. The handcontrol is plugged into a socket at the base of the Controller. The handcontrol can be hooked on the mast or boom when not in use.
4. **Emergency stop.** The large, red emergency stop button is located on the Control box and is activated by pressing in. This will cut all power to the Lift. It can be reset by twisting the button clockwise and releasing.
5. **Emergency raise/descent.** Emergency raise/descent buttons are provided. These are located underneath the emergency stop button. These can be activated by pushing with a ballpoint pen tip or similar. This will raise or lower the boom if the handcontrol fails. ***This function is to be used in an emergency only.***

Caution should be exercised when using this control as there is no automatic cut-out of the actuator when the bottom stop is reached.

6. **Emergency descent on actuator (2012 Models onwards).** An emergency descent handwheel is located at the top of the actuator. By turning it clockwise, this will lower the boom if the handcontrol fails.
7. **Batteries.** The batteries are protected from deep discharge by a LOW VOLTAGE ALARM. This will sound when the batteries need recharging and the handcontrol is being operated. It will not sound independently of the handcontrol being operated. **DO NOT IGNORE THIS WARNING ALARM.** Complete the lifting operation and place the Lift on charge (see charging instructions).

8. **Raising and lowering the boom (hydraulic models).** The raising and lowering of the boom is achieved by a powerful hydraulic ram which is operated by two simple controls. The release valve, which is identified by an aluminium knurled knob, and the pump handle which is a long lever on the side of the hydraulic unit.

To raise the boom, ensure the release valve is closed. The valve is closed by gently turning the knurled knob fully clockwise. When closed, pump the handle with smooth even strokes for maximum effect. The handle strokes from an upright position through an arc of 90°. Leave the handle in the upright position when not in use. **DO NOT** force the handle beyond the upper or lower stops. The hydraulic unit can be rotated to allow the handle to be used from either side of the lift.

To lower the boom, turn the release valve anticlockwise. The release valve is progressive, the more it is opened the faster the descent. This facility allows for a "hands free" descent. If the release valve is opened a fraction (a quarter turn) a very slow speed of descent will allow the carer to work "hands free" while assisting or comforting the patient.

REMEMBER to close the release valve before commencing lifting operations. The release valve only requires gentle pressure to open or close.

DO NOT apply excessive force to the release valve, either to open or close. It is not necessary and will only damage the valve.

9. **Slings.** The selected sling is attached to the spreader bar hooks, each sling is supplied with instructions and they are reproduced in this manual. The instructions should be followed carefully.

Two 12 vdc batteries are located in the power pack. They are charged through a figure of eight shaped socket in the base of the control unit. When charging is required the mains lead is plugged into a wall outlet and the socket in the base of the control box.

1. Fit the mains power lead to the small figure of eight shaped socket in the base of the control box.
2. Plug the charger mains plug into a suitable mains outlet and switch the mains supply **ON**.

Note: The Emergency Stop button has to be out of the battery pack to charge.

3. Charging is automatic and will fully charge the batteries over a period of eight to twelve hours.

Note: Even if the batteries are left on charge for extended periods the charger will not allow the batteries to "overcharge".

4. To return the Lift to service, switch **OFF** the mains supply. Remove the small plug from the socket in the control box. The Lift is now ready for use

Please pay particular attention to the following points, they will help you avoid problems with discharged batteries.

- **KEEP** the batteries fully charged. Place the power pack on charge whenever it is not in use. If it is more convenient to do so, place on charge every night. The charger will not allow the batteries to "overcharge".
- **NEVER** run the batteries completely flat. As soon as the audible warning sounds, complete the lifting operation and place the batteries on charge.
- **NEVER** store the power pack for long periods without regular charging throughout the storage period.
- **ALWAYS** make sure the mains power to the charger is switched off before connecting or disconnecting the power pack.
- **NEVER** leave the power pack plugged in to the charger with the mains power off.
- **ALWAYS** check Battery Charger Indicator (LCD) screen.
- **WARNING:** Walking away with the hoist while the charger is still plugged into the mains could cause the cable and the charger to short out.
- **NEVER** dispose of the Battery Pack in a fire as this may cause an explosion. If in doubt contact Unihoist Limited.

Correct way to charge the battery



All Unihoist products are designed for minimum maintenance, however some safety checks and procedures are required. A schedule of **DAILY** checks and tasks are detailed below.

Daily checks and biannual service, inspection and test will ensure a Lift is kept in optimum safe working condition. A list of spare parts is available upon request. The **LOAD TEST** and **CERTIFICATION** should only be carried out by qualified, competent personnel or an authorised service dealer.

Daily Check List

Unihoist Ltd strongly recommend the following daily checks are carried out before using the lift.

- **MAKE** sure the Lift moves freely on it's castors.
- **MAKE** sure the legs open and close correctly.
- **MAKE** sure the mast is fully engaged and the locking knob is fully tightened.
- **MAKE** sure the spreader bar is free to rotate and swing. Check the spreader bar is firmly attached to the boom.
- **EXAMINE** the sling hooks on the spreader bar and side suspenders for excessive wear. If in doubt – do not use.
- **OPERATE** the handcontrol or hydraulic unit to confirm the boom raises and lowers satisfactorily.
- **ON** electric powered lifts check the operation of the emergency stop button.
- **ON** hydraulically operated lifts check for hydraulic fluid leakage. Any leakage should be reported to a service engineer immediately and the lift should not be used until it has been checked out.
- **CONFIRM** the Lift is not giving a low battery alarm when the handcontrol is operated. If the alarm sounds **DO NOT** use and place on charge immediately.
- **EXAMINE** slings for fraying or other damage. **DO NOT** use any sling with fraying or damage to the suspension straps or tears in the body of the sling.
- **MAKE** sure the User Manual is available.

Unihoist Ltd recommend a through inspection and test of the Unihoist mobile lifting accessories, slings etc. is carried out every six months. The examination and test should be conducted according to the recommendations and procedures below.

Unihoist Ltd recommend maintenance, inspection and certified testing is carried out by authorised service dealers only.

Note: These recommendations are in compliance with the requirements of 1998 No.2307 Health and Safety: The Lifting Operations and Lifting Equipment Regulations 1998. This is a UK regulation. Outside the UK please check your local requirements.

- **SPREADER BAR:** Check the spreader bar for freedom of rotation and swing. Check the wear on the central pivot and the nylon washer. Check for firm attachment to the boom. Inspect for excessive wear on the sling hooks and any side suspenders used in conjunction with the spreader bar.
- **BOOM:** Check the attachment of the boom to the mast. Make sure there is only minimal side movement of the boom and the boom is free to rotate on the boom bearing. Check the actuator or hydraulic unit mounting on the boom.
- **MAST:** Check the operation of the mast locking device. Make sure the mast fully engages into the socket. Check the bottom actuator or hydraulic unit mounting.
- **CONTROL BOX** (Electric only): Check the function of the Emergency Stop Button. Inspect the hand control socket for correct fitting. Inspect the charging socket for correct fitting. Check functioning of hand control.
- **LEG ADJUSTMENT:** Check the leg linkages are secure and the leg adjustment handle is located correctly in the leg adjustment gate. Operate the leg adjusting handle and confirm smooth opening and closing of the legs. Adjust linkages if necessary.
- **LEG PIVOTS:** Check the leg pivots are secure and the legs pivot freely. Any stiffness must be investigated. Strip out the leg pivots and lubricate with a light mineral based grease if in any doubt. Make sure there is no excessive play in the leg pivots.
- **CASTORS:** Check all castors for firm attachment to the legs. Check for free rotation of castor and the wheels. Remove any build up of threads, hair or fluff. Lubricate if necessary with a light mineral based grease. Check correct operation of the brakes.
- **ACTUATOR** (Electric only): The actuator should require no maintenance other than checking for correct operation and listening for unusual noise and that it is correctly secured.

Maintenance, Inspection and Test contd.

- **ENSURE** all four castors are in contact with the floor when the hoist is moved.
- **EMERGENCY DOWN:** Check emergency down functions - control box and actuator (on 2012 models).
- **HYDRAULIC UNIT:** The hydraulic unit should require no maintenance other than checking for correct operation and leakage of hydraulic fluid.
- **BATTERIES** (Electric only): The batteries are located in the power pack and should not require maintenance other than the regular charging as detailed in the charging instructions.
- **CLEANING:** Clean thoroughly with ordinary soap and water and any hard surface disinfectant if required after cleaning (you cannot disinfect unless the hoist is already clean). Harsh chemical cleaners or abrasives should be avoided as these may damage the surface finish of the hoist. Avoid wetting any of the electrical parts.
- **LOAD TEST:** The load test should be carried out in accordance with the manufacturers test procedures. It is strongly recommended the testing is carried out by an authorised service dealer.
- **CERTIFICATION:** An authorised service dealer will issue a test certificate after satisfactory completion of the load test. This certificate will be valid for six months.

Model	Graduate 150		Scholar 175		Master 200	
	Electric	Hydraulic	Electric	Hydraulic	Electric	Hydraulic
Safe Working Load	150kg	150kg	175kg	175kg	200kg	200kg
Maximum Overall Length	1120	1120	1310	1310	1435	1435
Minimum Overall Length	1065	1065	1220	1220	1375	1475
Maximum Overall Height	1835	1840	2025	2080	2135	2150
Minimum Overall Height	1200	1200	1310	1310	1428	1428
Spreader Bar Maximum Height	1615	1605	1795	1850	1891	1905
Spreader Bar Minimum Height (usable)	432	483	530	628	530	395
Height at Maximum Reach	975	920	1070	1083	1200	1175
Reach at Maximum Height	225	240	245	210	450	435
Reach at Minimum Height	380	380	400	498	550	360
Maximum Reach	530	530	595	617	720	700
Turning Radius	1120	1120	1310	1310	1435	1435
Legs Open – External Width	1080	1080	1125	1125	1300	1300
Legs Open – Internal Width	935	935	980	980	1148	1148
Legs Close – External Width	688	685	685	685	705	705
Legs Close – Internal Width	542	542	540	540	560	560
Overall Height of Legs	110	110	110	110	115	115
Ground Clearance	43	43	43	43	17	17
Front twin castors	100	100	100	100	100	100
Rear Braked Castors	100	100	100	100	100	100
Minimum Distance from Wall to CSP at Maximum Height (legs spread)	420	450	605	645	473	485
Minimum Distance from Wall to CSP at Maximum Reach (legs spread)	115	125	220	210	204	205
Minimum Distance from Wall to CSP at Minimum Height (legs spread)	275	293	405	340	432	570
Weights						
Power Pack	3kg	-	3kg	-	3kg	-
Base assembly (not incl. battery pack)	14kg	14kg	15kg	15kg	19kg	19kg
Mast & Boom assembly (not incl. battery pack)	15.5kg	18kg	19kg	19.5kg	22kg	23kg
Total	32.5kg		37kg		44kg	

Note: Reach = Centre of spreader bar to front of actuator.

Specifications are for reference only and may vary due to manufacturing tolerances

Electrical Specifications

- Batteries 2 x 12 volt Rechargeable sealed lead acid type
- Battery Capacity 2.9 Ampere hours
- Charger Rated Input 230Vac 50/60 Hz
- Charger Rated Output 27.4/29.0 VDC@0.8A

Electric Shock Protection

Charger..... Class II
 LiftInternal Power Source

Degree of Shock Protection

Charger.....Type B
 Lift..... Type B
 Duty Cycle 10% (6 minutes per hour).

Sound Levels

	Graduate	Scholar	Master
Loaded	58.4dBA	58.7dBA	58.7dBA
Unloaded	58.5dBA	58.5dBA	58.5dBA

Dimensions (mm)

Model	Graduate 150 Hyd	Graduate 150 Elec	Scholar 175 Hyd	Scholar 175 Elec	Master 200 Hyd	Master 200 Elec
A	1187	1187	1307	1307	1422	1422
B	685	685	685	685	705	705
B'	540	540	540	540	560	560
B1	1080	1080	1125	1125	1300	1300
C	396	396	431	431	523	523
C1	180	180	254	254	286	286
C2	463	463	590	590	534	534
D	110	110	110	110	115	115
H2	1575	1575	1773	1773	1880	1880
H3	1835	1840	2025	2080	2135	2150
L	965	965	1125	1125	1207	1207
L'	255	255	367	367	420	420
T	582	582	582	582	582	582
T'	145	145	145	145	145	145

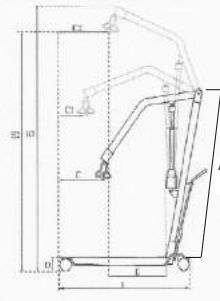
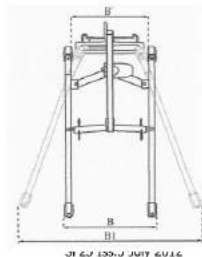
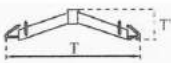

Slings for use with the Unihoist Ltd Mobile Hoist Range

Unihoist Ltd has designed a range of slings to be used with the Unihoist Ltd mobile hoist range:

- Easifit Sling
- Easifit Deluxe Sling
- Toileting Sling
- Deluxe Hammock Sling

Special requirement slings can be made to customers own specifications.

When selecting a sling from the Unihoist Ltd range ensure that the type of sling chosen is suitable for the patient to be lifted. The guides in the following pages will help in making the correct selection.

Please Note

The patient's final position in the sling can be adjusted by using varying combinations of the loops.

Warning!

A risk assessment should be carried out by a qualified person to ensure that the correct size, type and shape of Sling is being used for the patient.

Warning!

Always check the correct sling is appropriate as identified in the risk assessment/care plan.

Warning!

Always check that all the Sling straps are securely attached to the spreader bar before starting the lift.

Easifit Sling

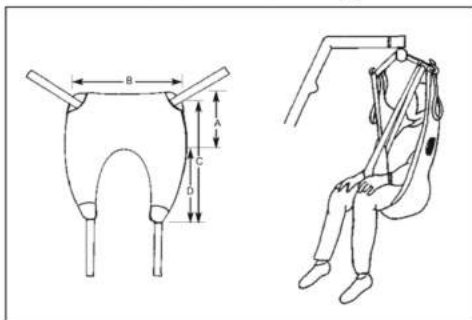

	Small	Med.	Large
A	530	620	740
B	770	900	1240
C	1150	1230	1410
D	610	640	650

ORDER CODE

SMALL	POLYESTER#F 150	NET #F 151
MEDIUM	POLYESTER#F 152	NET #F 153
LARGE	POLYESTER#F 154	NET #F 155

Trinity Toileting Sling

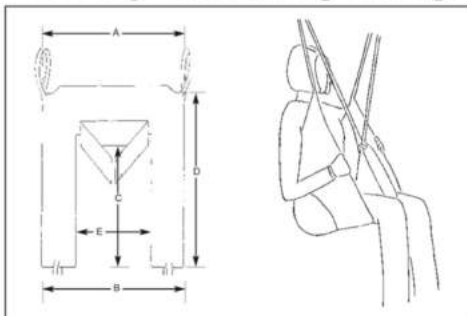

	Small	Med.	Large
A	730	850	1030
B	770	900	1090
C	530	680	800
D	870	990	1180
E	340	340	560

ORDER CODE

SMALL	POLYESTER#F 159	NET #F 160
MEDIUM	POLYESTER#F 161	NET #F 162
LARGE	POLYESTER#F 163	NET #F 164

Easifit Deluxe

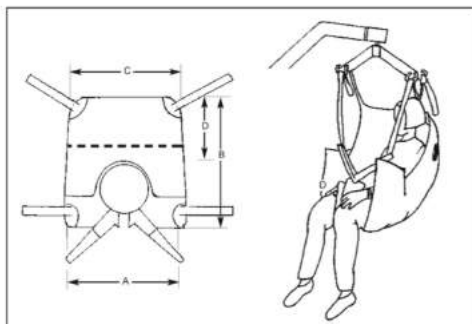

	Small	Med.	Large
A	940	980	1090
B	880	950	1040
C	810	880	970
D	700	750	800

ORDER CODE

SMALL	POLYESTER#F 156	NET #F 171
MEDIUM	POLYESTER#F 157	NET #F 172
LARGE	POLYESTER#F 158	NET #F 173

De Luxe Hammock Sling

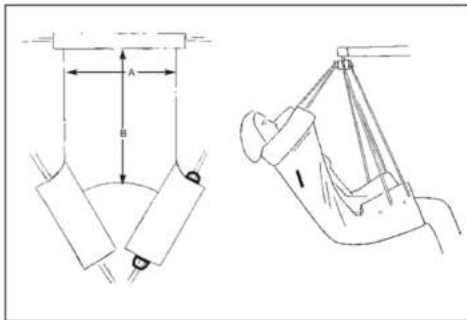

	Small	Med.	Large
A	650	740	850
B	850	950	1050

ORDER CODE

SMALL	POLYESTER#F 165	NET #F 166
MEDIUM	POLYESTER#F 167	NET #F 168
LARGE	POLYESTER#F 169	NET #F 170

Sizing – all slings

Each sling is marked with the following coded symbols, two or three of which will be crossed out. Your sling will be the size that is **not** crossed out. In the example shown below, the size of the sling is small. (On the actual label, the symbol will be blue and the sling will have red piping)

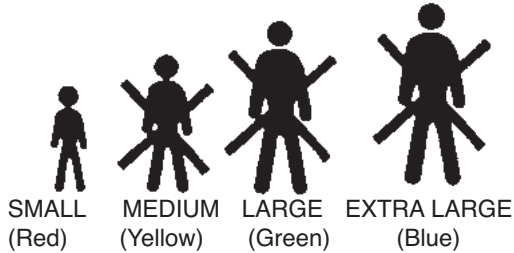

The straps on the sling are also colour coded. For example, a large sling will have green loops in the positions normally used for a large patient.

The following sizing chart is offered as a guide only and each patient should be assessed individually.

Small	70 – 126 lbs	32 – 57 kgs
Medium	126 – 196 lbs	57 – 89 kgs
Large	196 – 350 lbs	89 – 159 kgs
Extra Large	350 – 440 lbs	159 – 200 kgs

The maximum safe working load of the Easifit Sling is 210 kgs.

Important: All slings in the Unihoist Ltd range are rated at a safe working load of 210kgs. This is to ensure that any of these slings can be used with safety. **It is important to take the safe working load of the lift as the maximum permissible load of any lifting operation.**

Washing Instructions:

- Wash in a mild soap solution up to 71°C
- Do not use biological detergents
- Do not bleach
- Dry in a warm room or in the open air
- Do not place on convector heaters or steam pipes
- Do not dry in tumble dryers which exceed 120°C
- Please ensure that the velcro components on the Slings are stuck together before washing to ensure that the velcro does not rub against the sling material.

SYMBOLS



Do not exceed 71 degrees centigrade



Do not bleach

The Easifit sling is a general purpose sling designed to suitable for most patients, but it **is unsuitable for lifting amputees**. Other patients must be assessed for suitability by a qualified person.

The Easifit sling is suitable for the following categories of lift:

- Category A – Wheelchair
- Category B – Bed
- Category C – Bath
- Category D – Toilet/Shower chair
- Category E – Floor

The Easifit sling can be used for patients in the SITTING, SITTING/RECLINING and RECUMBENT positions.

The Easifit sling has been designed to fit on the standard six hook spreader bar.

Unihoist Ltd recommend slings are checked regularly and before use for fraying and damage. **DO NOT** use any slings which are worn or damaged.

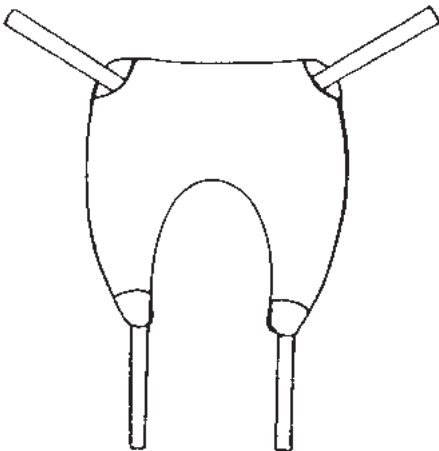

Fig. 1



Fig. 2

Sitting, Sitting/Reclining Position

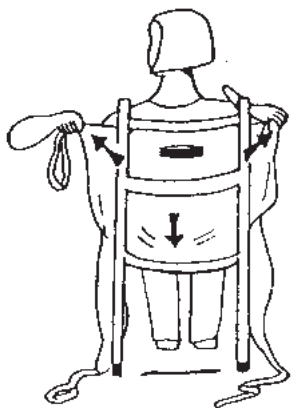

Fig. 3

Ensure that the handgrips and seams are on the outside of the sling. Slide the sling down the back of the client. The commode aperture should be at the base of the back. The sling should be square across the shoulders

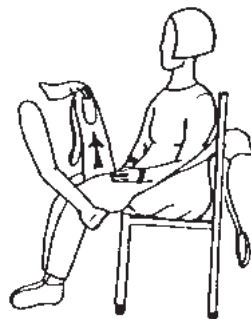

Fig. 4

Lift the patient's legs one by one and feed the leg straps under and between the legs.

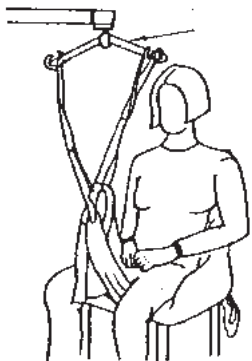

Fig. 5

Cross over the leg straps and attach the longest loops to the front hooks on the spreader bar

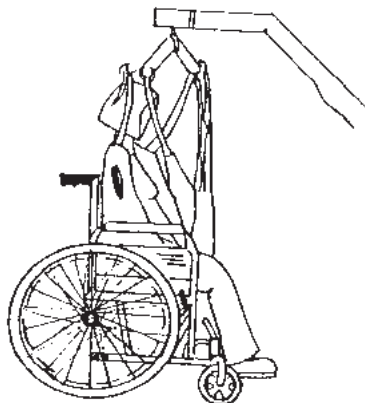

Fig. 6

Raise the hoist and attach the shortest loops on the shoulder straps to the hooks on the spreader bar. The hoist may move towards the client as the operation is undertaken

Lying down position (Recumbent)

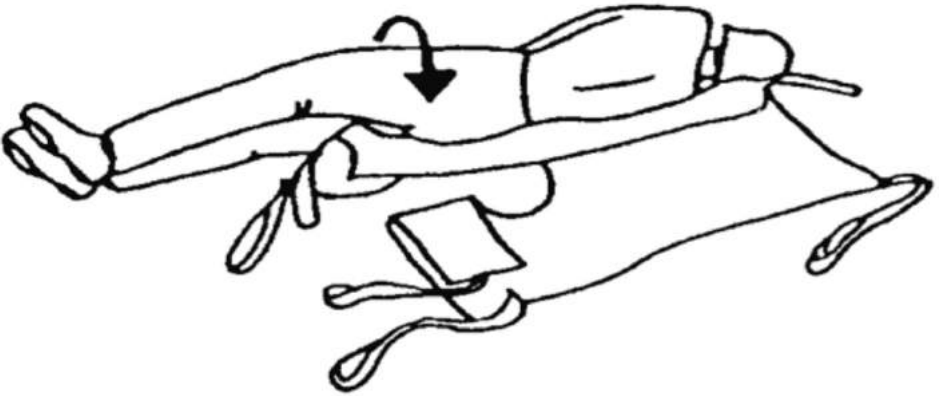

Fig.7

"Log roll" the patient onto the sling. The commode aperture should be at the base of the spine.

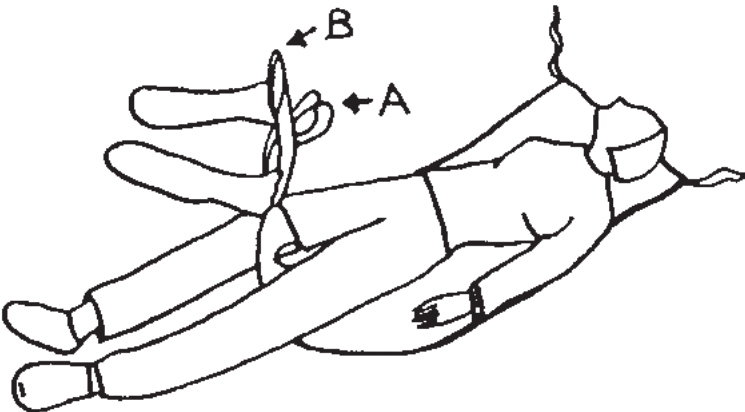

Fig.8

Cross the leg straps between the legs and proceed to attach the sling as from the seated position. Use the shortest shoulder strap possible. Proceed to attach the sling to the spreader bar in the same way as for the sitting position.

The Easifit Deluxe sling is a development of the Easifit sling. It provides a more comfortable and supportive lift. It is also available with head support and can be fleece lined for additional comfort. This sling is suitable for the lifting of some amputees but patients must be assessed individually by a qualified person to determine whether this sling is suitable for their use.

The Easifit Deluxe sling is suitable for the following categories of lift:

- Category A – Wheelchair
- Category B – Bed
- Category C – Bath
- Category D – Toilet/Shower chair
- Category E – Floor

The Easifit Deluxe sling can be used for patients in the SITTING, SITTING/RECLINING and RECUMBENT positions.

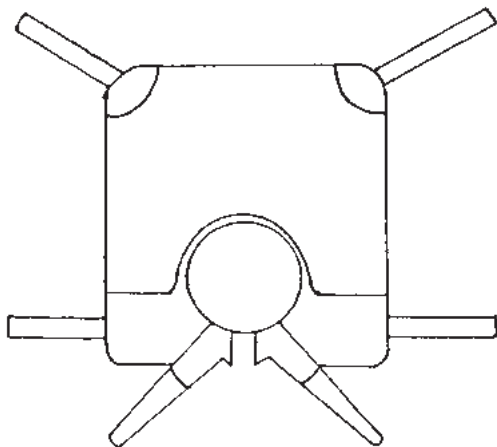

Fig.9

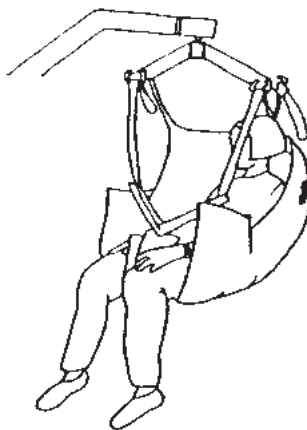

Fig. 10

The Easifit Deluxe sling has been designed for use with the six hook spreader bar.

Unihoist Ltd recommend slings are checked regularly and before use for fraying and damage. DO NOT use any slings which are worn or damaged.

Sitting, sitting/reclining Position

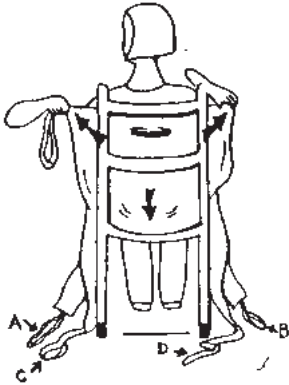

Fig. 11

Ensure that the handgrips and seams are on the outside of the sling. Slide the sling down the back of the patient. The commode aperture should be at the base of the back. The sling should be square across the shoulders.

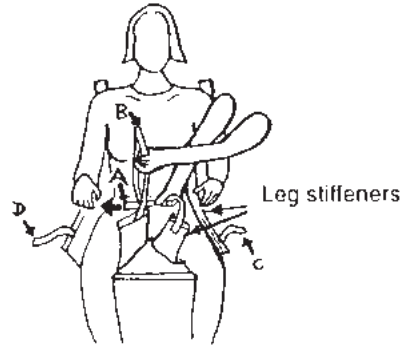

Fig.12

Bring the longest leg piece forward so that it is parallel with the long leg bone of the thigh. Ensuring that the leg piece is not twisted, take the shortest leg piece stiffener under and up between the legs. Repeat this process with the other leg.

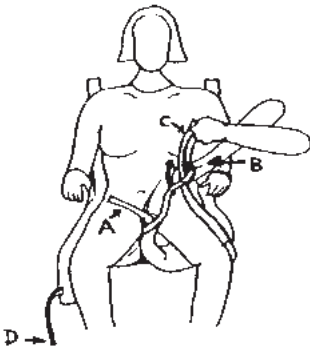

Fig. 13

Pass strap C through strap B. Repeat for the other leg passing strap D through strap A



Fig. 14

Check the sling is smooth under the client and confirm the position is comfortable. Move the hoist into position and attach the leg straps to the spreader bar by the coloured loops. This maintains the patient in an upright sitting position. The hoist may move towards the patient as you do this. When re-seating the patient, the handgrips may ensure a good position.

Alternative sitting, sitting/reclining

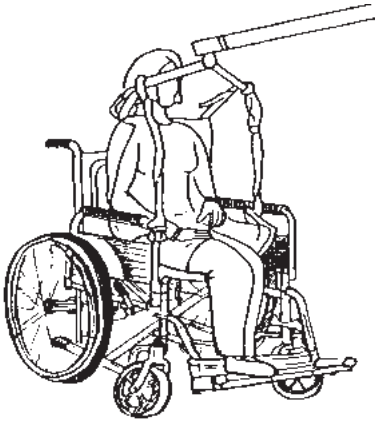

Fig. 15

For closed leg position, straps may be crossed under both legs and attached as illustrated. Ensure leg straps C and D are passed through straps A and B and attached to the spreader bar. This can provide additional comfort and can be used for some amputees.

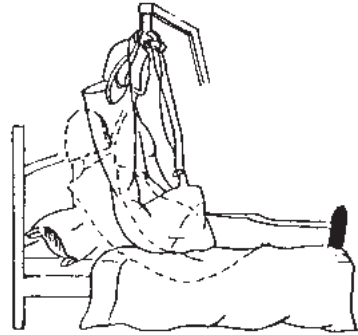

Fig.16

The longer the length of the shoulder straps, the more reclined the client will be. Cross strap A through strap B

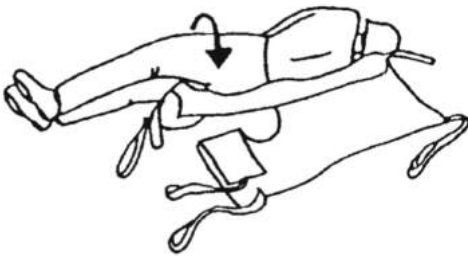

Fig. 17

"Log-roll" the client onto the sling, making sure that the commode aperture is at the base of the back.

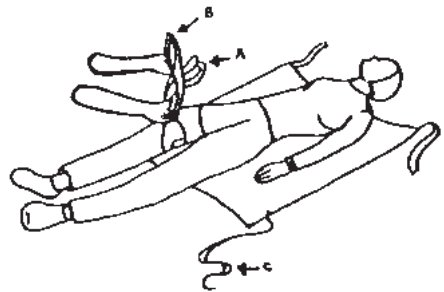

Fig. 18

Cross leg strap A and B under and between the legs and feed A through B. Feed C and D through the long loops on A and B. Then attach the sling to the spreader bar in the same way as the sitting position.

Washing and sizing instructions are as the Sizing - All Slings page.

Instruction guide for the Toileting Sling

The toileting sling has been designed specifically to facilitate toileting. It is an easy way to fit sling, padded for comfort, and allows access to and the removal of clothing. It is not a general purpose sling and will only suit approximately 25% of clients. The clients must be able to support themselves in the sling. This sling is unsuitable for lifting amputees. Other clients must be assessed for suitability by a qualified person.

The toileting sling is suitable for the following categories of lift:

- Category A – Wheelchair
- Category D – Toilet/Shower chair

The toileting sling can be used for clients in the SITTING position only.

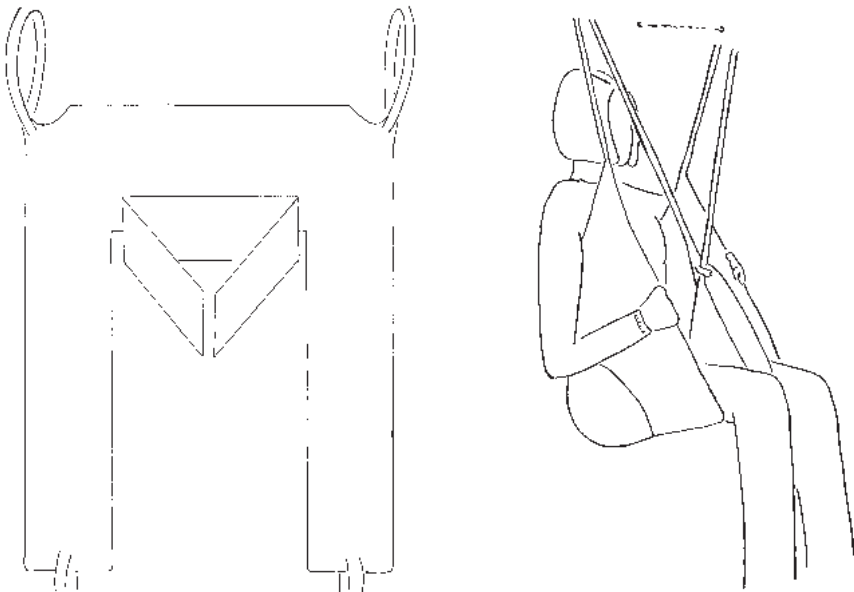

Toileting Sling

The toileting sling has been designed for use with the six hook spreader bar.

Unihoist Ltd recommend slings are checked regularly and before use for fraying and damage. **DO NOT** use any slings which are worn or damaged.

Sitting position

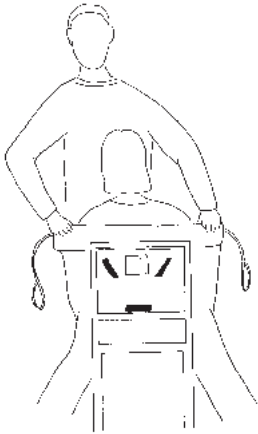

Fig.19

Place the sling down the back to a position just beneath the shoulder blades and above the belt line.

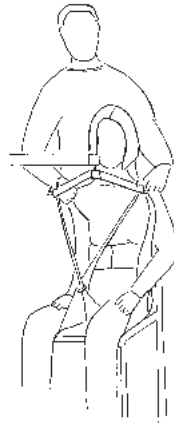

Fig.20

Raise the clients leg and feed the leg strap under and up between the legs. Make sure the sling is not twisted or creased under the thigh. Repeat the procedure for the other leg.

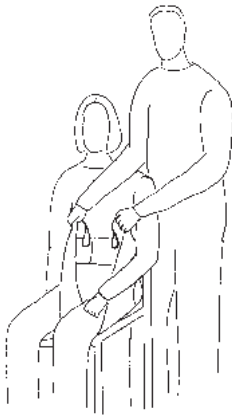

Fig.21

Cross over the leg straps and attach the longest loops to the front hooks on the spreader bar. Raise the lift and attach the shoulder loops to the rear hooks (a more upright position can be achieved on the shortest loop). The lift may move towards the patient when you do this.

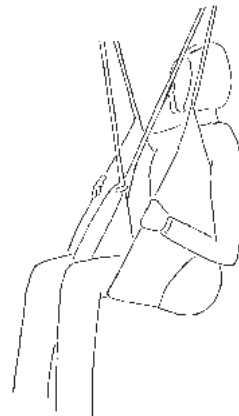

Fig.22

Raise the lift to the required height. When re-seating the client light pressure on the thigh will ensure a good posture.

Washing and sizing instructions are as the Sizing - All Slings page.

The Deluxe Hammock sling has been designed for amputees but it is also suitable for other clients who have to remain in the sling for an extended period, such as for bed making or bathing. It is available with or without a commode aperture. A head support attachment is also available. The sling can be fleece lined for additional comfort.

The Deluxe Hammock sling is suitable for the lifting of amputees, but clients must be individually assessed for suitability by a qualified person.

The Deluxe Hammock sling is suitable for the following categories of lift:

- Category B – Bed
- Category E – Floor

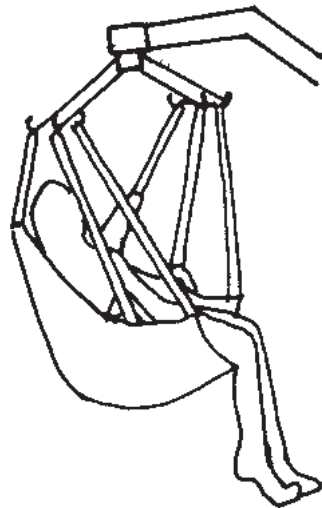
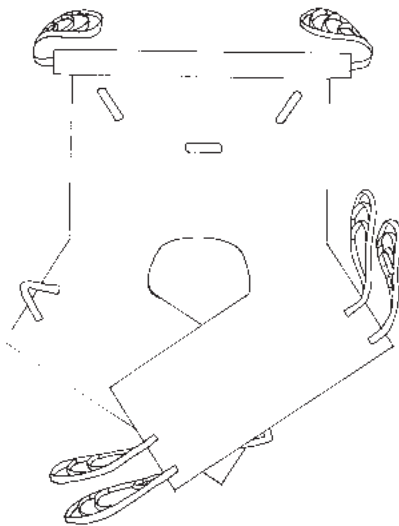

The Deluxe Hammock sling has been designed for use with the six hook spreader bar.

Unihoist Ltd recommend slings are checked regularly and before use for fraying and damage. **DO NOT** use any slings which are worn or damaged.

Sitting Position

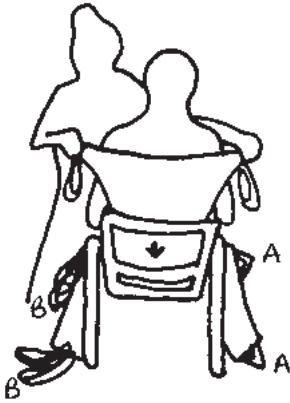

Fig.23

Ensure the hand grips are on the outside, away from the client. Place the sling down the back so that the sling is square at the shoulders.

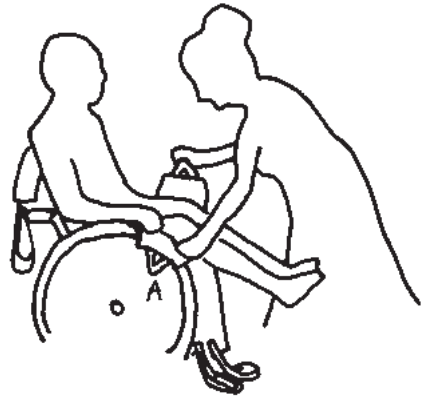

Fig.24

Raise the clients leg and feed the 1st leg piece with the "A" straps under the leg. Do the same with the other leg, feeding the 2nd piece with the "B" straps under the 1st leg piece.

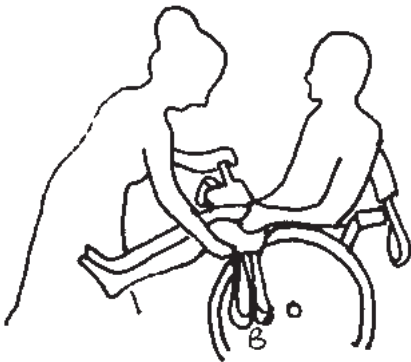

Fig.25

Feed the back "B" strap through the "A" strap on both sides of the sling. Move the hoist into position and attach the four leg straps to the spreader bar. Raise the hoist and attach the shoulder straps.

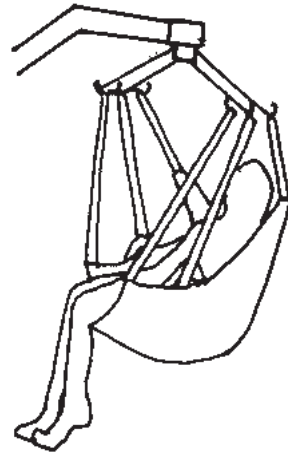

Fig.26

All six hooks on the spreader bar should now have a strap attached. Raise the hoist to the required height. Please note: the longer the shoulder strap is, the more reclined the client will be.

Washing and sizing instructions are as the Sizing - All Slings page.

Trouble Shooting Guide

Symptom	Possible Cause	Remedy
Nothing happens when the handset buttons are pressed	<ol style="list-style-type: none"> 1. Emergency stop button pressed in. 2. Handset not plugged in 3. Actuator not plugged in 4. Bad contact on handset 5. Battery fuse blown 6. Charger connected 7. Battery not seated on control box 	<ol style="list-style-type: none"> 1. Reset emergency stop switch 2. Plug in correctly 3. Plug in correctly 4. Change handset 5. Call Service Engineer 6. Unplug charger 7. Reseat battery and check latch is engaged
Hoist lacks lifting power	<ol style="list-style-type: none"> 1. Battery low 2. Actuator failing 3. Control box failing 	<ol style="list-style-type: none"> 1. Charge battery 2. Call Service Engineer 3. Call Service Engineer
Actuator stops intermittently during raising	<ol style="list-style-type: none"> 1. Load too heavy 2. Battery low 3. Actuator overheating 4. Actuator failing 5. Control box failing 	<ol style="list-style-type: none"> 1. Check Safe Working Load of hoist 2. Charge battery 3. Call Service Engineer 4. Call Service Engineer 5. Call Service Engineer
Actuator noisy	<ol style="list-style-type: none"> 1. New actuator – grease unevenly distributed (not run in) 2. Old actuator – unit failing 	<ol style="list-style-type: none"> 1. Cycle actuator on no load and on light load 2. Call Service Engineer
Actuator runs but does not lift	Gears damaged	Call Service Engineer
Actuator only runs in one direction	<ol style="list-style-type: none"> 1. Control box failure 2. Handset switch failure 3. Handset lead, plug or socket damaged 	<ol style="list-style-type: none"> 1. Call Service Engineer 2. Replace handset 3. Replace Handset
Battery will not charge	<ol style="list-style-type: none"> 1. Mains lead unplugged 2. Mains socket not switched on 3. Mains lead damaged 4. Mains fuse blown 5. Battery fuse blown 6. Battery not seated on control box correctly 7. Battery discharged below minimum level 8. Battery charger failed 	<ol style="list-style-type: none"> 1. Plug in mains plug 2. Switch power on 3. Replace mains lead 4. Replace fuse (once only) 5. Call Service Engineer 6. Reseat battery and check latch is engaged 7. Call Service Engineer 8. Call Service Engineer

Disposal of Waste Electrical and Electronic Equipment

The WEEE Regulations (Waste and Electronic Equipment Regulations 2006) have been introduced to control how waste electrical and electronic equipment is disposed of.

The regulations aim to promote reuse, recycling and recovery.

Unihoist Ltd has an established network of reputable distributors and dealers who will be pleased to handle all your purchasing, warranty, repair and maintenance enquiries.

Included with each lift is a Customer Satisfaction card. Please take the time to fill it in and return it to Unihoist Ltd. Our products are guaranteed for a period of twelve months from the date of manufacture or twelve months from the date of purchase if commissioned by an authorised dealer. We recommend that all of our products are commissioned by your dealer and are supported by them for future servicing.

The dealer or distributor operates the warranty programme, so it is important to keep a record of their name, address and telephone number so they can be contacted should any problem arise.

If you are in doubt where your lift was purchased, Unihoist Ltd can trace the supplier if you quote the serial number of your lift.

Remember: Contact your distributor for purchases, warranty, repairs, servicing and annual certified maintenance.

When servicing a hoist only authorised Unihoist Ltd. parts should be used.



Unihoist Ltd
Unit C, Anvil Court,
Stanton Harcourt Road,
Eynsham, Oxon.
OX29 4UD

Tel: 01865 881881 Fax: 01865 883434
Email: unihoistltd@btconnect.com or sales@unihoist.co.uk
www.unihoist.co.uk

