

User Instruction Manual

Oxford® Elara Ceiling Lifts

To avoid injury, read user manual prior to use.

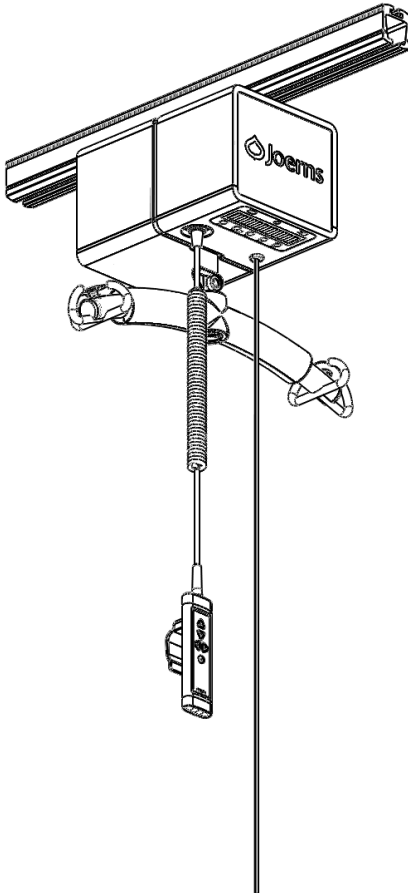

Contents

1. Introduction.....	3
2. The Oxford Elara Ceiling Lift.....	4
3. Safety Precautions.....	7
4. Operating Instructions.....	11
5. Batteries and Charging.....	36
6. Care and Maintenance Schedule.....	40
7. Trouble Shooting.....	44
8. Technical Specification.....	46
9. Warranty.....	52

Manufacturer Information

Joerns Healthcare Ltd. Drakes Broughton Business Park, Worcester Road, Drakes Broughton, Pershore, Worcestershire, WR10 2AG. England.

DO NOT DESTROY

THIS MANUAL SHOULD BE KEPT WITH THE LIFT AT ALL TIMES

Design Policy and Copyright

Joerns Healthcare August 2018

As our policy is one of continuous improvement, we reserve the right to modify designs without prior notice.

The content of this publication may not be copied either whole or in part without the consent of Joerns Healthcare.

1. Introduction

Please take time to read this manual thoroughly prior to using your Oxford Elara ceiling lift. The information contained in this manual is vital for the correct operation and maintenance of the equipment and will help ensure that both the patient and caregiver remain safe and free from injury throughout the lifting and transfer process. Furthermore, it will ensure the user is familiar with the lift's features and functions.

To help avoid injuries to both caregiver and patient, Joerns Healthcare recommends using only genuine Joerns Healthcare parts for servicing and repairs. Joerns Healthcare will not be held responsible for any accidents or incidents resulting from unauthorised servicing or the use of unauthorised parts.

If you are unsure on the use of this product and/or associated accessories, please contact your local authorised service providers or Joerns Healthcare direct for further advice.

WARNING

- **Prior to each and every use of your Oxford Elara ceiling lift, the daily checks detailed in the checklist in this manual should be carried out.**
- **Do not attempt to use your Oxford Elara ceiling lift without fully understanding this manual.**
- **Unauthorised modifications on any Oxford Elara ceiling lift equipment may affect its safety. Joerns Healthcare will not be held responsible for any accidents, incidents or deficiencies in performance that may occur as a result of any unauthorised modifications.**
- **The Oxford Elara lift unit is a reusable medical device intended to be used with patients whose weight is within the specified maximum safe working load. DO NOT attempt to lift more than the maximum safe working load of the lowest rated component within the system, considering the following:**
 - Track/rail system
 - Lift motor unit
 - Spreader bar or cradle
 - Sling
 - Accessories (e.g. weigh-scale)
- **The Oxford Elara ceiling lift is not intended for use during patient treatment.**
- **The Oxford Elara ceiling lift is not intended for use in environments where there is a risk of it being splashed with water.**
- **If the Oxford Elara ceiling lift interferes with any other equipment it MUST be moved away from the equipment.**

Definitions Used in this Manual

WARNING

Means: Failure to understand and follow these instructions may result in injury to yourself and others.

CAUTION

Means: Failure to understand and follow these instructions may result in damage to the product.

NOTE:

Means: This is important information regarding the correct use of the equipment.

Accompanying Documents

A number of documents are supplied in a wallet supplied with each ceiling lift and should be retained for future reference.

- Test Certificate
- User Manual

The TEST CERTIFICATE is an important document and is required for your insurance records. It is valid for 6 months from date of installation and once expired, the lift should be inspected and serviced in accordance with the information provided in the Service Manual. It is recommended that inspection/servicing is only carried out by an authorised Joerns Healthcare service provider.

2. The Oxford Elara Ceiling Lift

NOTE: Your Oxford Elara ceiling lift has purposely been electrically disabled for transportation to prevent accidental activation and battery drainage. The lift must be commissioned by an authorised Joerns Healthcare service provider prior to use.

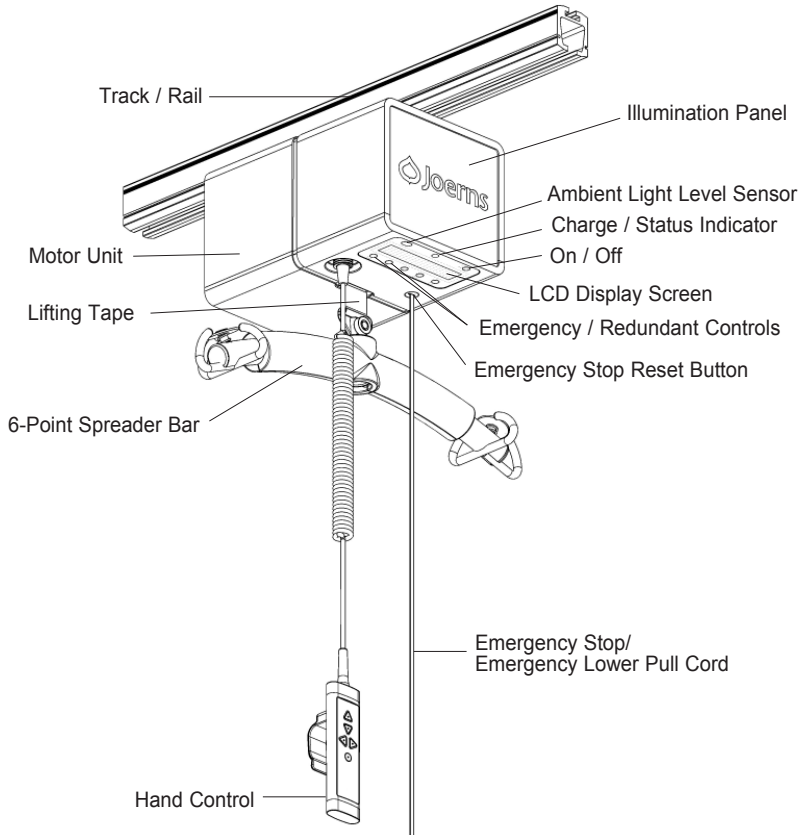

⚠ WARNING

The Oxford Elara lift units require tools and techniques for correct and safe installation. Incorrect installation may result in damage to the lift and injury to operators and patients. Installation and commissioning should be carried out by fully trained and authorised installers. Please contact your local Joerns Healthcare service provider to arrange installation.

The CE Mark

All Oxford Elara ceiling lifts carry the CE mark and comply with the following directives and standards:

- Medical Device Directive (93/42/EEC)
- General: IEC 60601-1:2006 (Third Edition) + A12:2014 Medical Electrical Equipment General requirements
- IEC 60601-1-11:2015 (Second Edition) Medical Electrical equipment and medical electrical systems used in the home healthcare environment
- EMC: IEC 60601-1-2:2015 - Medical Electrical Equipment Electromagnetic Compatibility
- ISO 10535:2006 - Hoists for the transfer of disabled persons requirements and test methods.
- Low Voltage Directive (73/23/EEC)
- IEC 61000-3-2: 2014 - Limits for Harmonic Current Emissions
- IEC 61000-3-3: 2013 - Limits of Voltage Fluctuations and Flicker
- IEC 62304: 2006 Medical Device Software - Software life cycle processes
- IEC 62366: 2007 Medical devices - Application of usability engineering to Medical Devices



Statement of Intended Use

The Oxford Elara ceiling lift is an overhead mounted patient handling device intended for the safe lifting, repositioning and transferring of a patient up to a safe working load of 227 or 284kg (model dependent). It is suitable for patients in the sitting, sitting/recumbent and recumbent positions.

It is imperative that the lift and its associated components are installed by a competent and trained engineer employed by an authorised Joerns Healthcare service provider and in accordance with local codes.

NOTE: The Oxford Elara ceiling lift does not contain any parts or mechanisms that are intended to be applied directly to the patient via physical contact.

WARNING

Joerns Healthcare ceiling lifts should only be operated by fully trained/competent caregivers.

Expected Service Life

Joerns Healthcare ceiling lifts are designed and tested for a minimum service life of 10 years. This is based on strict adherence to the daily checks stated in this user manual and the instructions detailed in the Service Manual. All service repairs must be performed by a competent and trained engineer employed by a Joerns Healthcare authorised service provider.

The expected service life for consumable components such as batteries, fuses, lamps and lifting tapes is dependent on care and usage of the equipment concerned. Consumable components must be maintained in accordance with the 'Preventative Maintenance Schedule' in this manual.

Lifting Tape Inspection and Renewal

WARNING

The lifting tape must be inspected for wear, damage, fraying, cuts, discoloration and loose or damaged threads by the user/caregiver BEFORE EVERY USE. If any deterioration is detected DO NOT USE THE LIFT and contact your authorised Joerns Healthcare service provider to arrange replacement.

Lift Tape Replacement

As part of the bi-annual inspection schedule, the lifting tape should be inspected for wear, damage, fraying, cuts, discoloration and loose or damaged threads and replaced as necessary. Regardless of its condition, Joerns Healthcare recommend the lifting tape is replaced every 5 years or 5000 lift cycles, whichever comes first.

Packing & Delivery

In the unlikely event of future breakdown, it is recommended that packaging is retained. This will help minimise the possibility of transit damage if the need to return goods arises.

Equipment Identification

The equipment identification (serial number, model number and manufacturing date) and specification (safe working load, electrical rating/electrical details in accordance with IEC 60601-1:2006 + A12:2014, manufacturer's details) are detailed on the label affixed to the unit's moulded cabinet.

3. Safety Precautions

Please read and follow the safety precautions listed below. The operation and use of Joerns Healthcare ceiling lifts is simple and straight-forward. Following these few basic safety precautions will make lifting operations safe, easy and trouble free. These safety instructions should be kept with the ceiling lift at all times.

Read and fully understand the Operating Instructions detailed in this manual before installing, operating or servicing this equipment.

⚠ WARNING

The Oxford Elara ceiling lift is only intended for operation by a competent/trained caregiver. It should **NEVER** be used by the patient for self hoisting.

Safe Working Load (SWL)

- The Oxford Elara 227 has been designed and tested to a maximum lifting capacity of 227kg.
- The Oxford Elara 284 has been designed and tested to a maximum lifting capacity of 284kg.

⚠ WARNING

The Oxford Elara lift unit is intended to be used with patients whose weight is within the specified maximum safe working load. **DO NOT** attempt to lift more than the maximum safe working load of the lowest rated component within the system, considering the following:

- Track/rail system
- Lift motor unit
- Spreader bar or cradle
- Sling
- Accessories (e.g. weigh-scale)

Important Safety Directions

⚠ WARNING

- Oxford Elara ceiling lifts should **ONLY** be operated by fully trained/competent caregivers.
- **ALWAYS** plan your lifting operation before commencing.
- **ALWAYS** carry out the 'DAILY CHECKLIST' in this manual before using an Oxford Elara ceiling lift.
- **ALWAYS** ensure Oxford Elara ceiling lifts are installed and commissioned by an authorised Joerns Healthcare service provider or in accordance with the information in the accompanying documents.
- Oxford Elara ceiling lifts are intended for the lifting and transferring of patients **ONLY**. The lifts should **NOT** be used for any other purpose.
- **ALWAYS** position any sling used in conjunction with the Oxford Elara ceiling lift in accordance with the instructions detailed in the sling's user instruction manual. Failure to do so may result in injuries to the caregiver and/or the patient.
- Ensure the equipment is **ONLY** used by trained personnel.
- **ENSURE** the track installation will accept a load equal to or greater than the capacity of the ceiling lift.

Contraindications

- There are no known contraindications.

WARNING

- Before using an Oxford Elara ceiling lift, a clinical assessment of the patient's suitability for transfer **MUST** be performed by a qualified health professional to evaluate aspects of the transfer procedure, including the possibility that the transfer procedure may exert substantial pressure on the patient's body.
- Oxford Elara ceiling lifts should **NOT** be operated by any person who is under the influence of alcohol, drugs or prescribed medication, that may adversely affect their ability to operate the equipment safely.
- **ENSURE** a full risk assessment is conducted prior to attempting to lift or transfer a patient.
- **ENSURE** an assessment of the suitability for transfer of any patient who is connected to electrodes, catheters or other medical devices is conducted by a qualified person prior to commencing a lift or transfer.
- Excessive impact during lifting and transfer activity should be avoided.
- Joerns Healthcare warns of possible risks of strangulation related to the lifting tape and advises necessary precautions should be taken to prevent this. Ensure the lifting operation is supervised by fully trained/competent caregiver.
- **ENSURE** the sling being used for the lift/transfer is compatible with the spreader bar, is suitable for the task and will sustain the weight of the patient being lifted.
- **ENSURE** the sling being used is in a serviceable and safe condition.
- **ENSURE** the lifting procedures outlined in this manual are adhered to.
- **ALWAYS** make sure any controls and safety features are used **ONLY** in strict accordance with the instructions within this manual. **NEVER** attempt to force a control or operating button on the lift.
- **ENSURE** the sling straps are correctly and securely attached to the spreader bar.
- To avoid the risk of injuries attributed to the use of inadequate replacement parts, Joerns Healthcare strongly advises and warns that only Joerns Healthcare approved parts should be used on equipment and other appliances manufactured by Joerns Healthcare. Unauthorised modifications on any Joerns Healthcare equipment may adversely affect its safety. Joerns Healthcare will not be held responsible for any accidents, incidents or lack of performance that occur as a result of any unauthorised modifications or the use of non-approved parts.

CAUTION

- Keep all components of the Oxford Elara ceiling lift clean and dry and **ENSURE** the safety checks outlined in this manual are carried out as directed.
- Excessive exposure of the hand control to water or other liquids may cause malfunction of the device.
- **DO NOT** drop the Oxford Elara ceiling lift unit. This may result in internal damage that is not visible. If it is suspected that the ceiling lift may have sustained damage, **DO NOT** use the unit and contact your local approved Joerns Healthcare service provider for inspection/servicing.

No User Serviceable Parts

WARNING

- DO NOT attempt to service or repair the Oxford Elara ceiling lifts, batteries or charger. If the unit is malfunctioning, contact your local authorised Joerns Healthcare service provider.

Shock Prevention

WARNING

- DO NOT touch or use a lift with exposed conductors or a damaged power cord. Electrically live equipment can result in serious injuries. If the lift or charger have any exposed or damaged wires, contact your local authorised Joerns Healthcare service provider immediately.
- DO NOT splash or expose electrical parts of the device to water or moisture.
- CHECK the charger nameplate for the input voltage and frequency requirements. These requirements differ by country/region. DO NOT attempt to use the lift in a region that has a different voltage and frequency to that specified on the nameplate.
- ALWAYS read the battery and charger instructions prior to using, storing or disposing of them.

Fire and Explosion Prevention

WARNING

- DO NOT place the Oxford Elara ceiling lift in direct sunlight or near a heat source.
- DO NOT expose the Oxford Elara ceiling lift or the battery charger to flames.
- DO NOT use the Oxford Elara ceiling lift unit in the presence of flammable anaesthetic mixtures with air or oxygen, or with nitrous oxide.
- DO NOT use the Oxford Elara ceiling lift in locations where heavy dust or lint may be evident.

Human and Environmental Safety Practices

WARNING

- In the unlikely event that the Oxford Elara ceiling lift casing and the casing on the battery become cracked and cause the contents to come into contact with the skin or clothing, immediately rinse with plenty of water.
- Should the contents come into contact with the eyes, immediately rinse with plenty of water and seek medical attention.
- Inhalation of the contents can cause respiratory irritation. In this event, provide fresh air and seek medical attention.
- This product contains sealed lead acid batteries. For recycling and disposal, please contact your local authorised Joerns Healthcare service provider.
- DO NOT allow children to operate the Oxford Elara ceiling lift.
- No known effects caused by pets or pests.



Locating and Isolating Electrical Power

- Before using the Oxford Elara ceiling lift, ensure you are aware of the location of the mains power connection and how to isolate (switch-off) the mains power.

Battery & Battery Charger Safety Practices

WARNING

- Following these instructions is important for the safe use of the batteries and to keep the user (patient/caregiver) from harm. The batteries in this device are rechargeable Vent Regulated Lead Acid (sealed lead-acid).
- **DO NOT** expose the battery charger to water or other liquids.
- **DO NOT** expose the battery charger to flames or sources of ignition.
- **ONLY** use the charger that has been supplied with the equipment. **DO NOT** charge the Oxford Elara ceiling lift in an unventilated area.
- The charger must **NEVER** be covered or exposed to dust.
- The charger is designed for use in dry areas only and for normal air humidity conditions. It should **NOT** be used in condensing humidity conditions.

NOTE: After taking delivery of an Oxford Elara ceiling lift unit, the batteries should be charged for a minimum of 8 hours prior to initial use.

NOTE: Prior to operation, allow the Oxford Elara ceiling lift unit to attain the following operational conditions within a 6 - 10 hour period of time:

- Relative humidity should be between 15% to 93% non-condensing.
- Ambient temperature should be between +5°C to +40°C (+41°F to +104°F).
- Atmospheric pressure should be between 700 hPa to 1060 hPa.

Equipment Warning Labels

WARNING

- Inspect **ALL** precautionary labels on the equipment. Order and replace any labels that are illegible.

4. Operating Instructions

⚠ WARNING

Oxford Elara ceiling lifts should only be operated by fully trained/competent caregivers. They should NEVER be operated by an unattended patient alone.

4-way Elara Unit Illustration

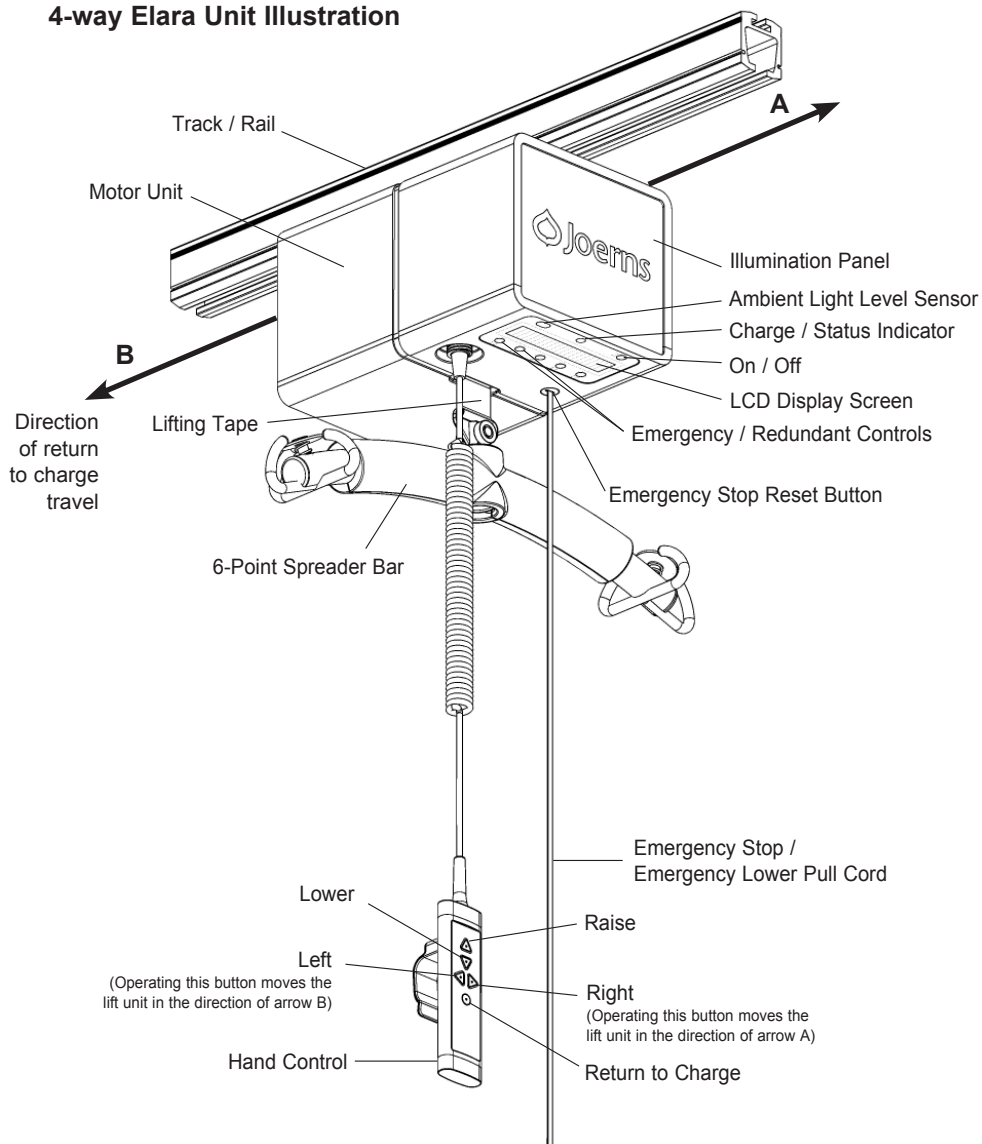

On/Off Switch

Push the on/off button to turn on the lift. The charge / status indicator and LCD display screen will illuminate. When the lift is in operation mode, push the ON / OFF button to switch the unit off.

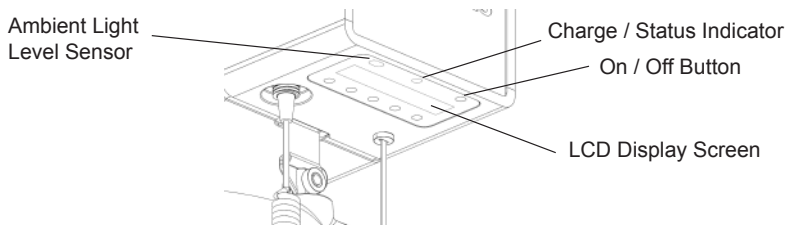

Charge / Status Indicator

After approximately 10 seconds from when any command button has been depressed or following power up using the on/off button the charge / status indicator pulses green to indicate the batteries are charging. Additionally the battery charge indicator on the left of the LCD display screen will show the actual charge remaining.



Batteries 1/3rd charged - For 'End-of-Rail' charge systems the lift unit should be returned to the charge station immediately once the lifting procedure is complete. When the batteries charge level reaches this critically low condition, the charge / status indicator will flash red and, in ambient light conditions, this will be accompanied by an audible beep each time an operating control is depressed. In low light conditions, only the charge / status indicator will flash red.



Batteries 2/3rd charged - For 'End-of-Rail' charge systems the lift unit should be returned to the charge station.



Batteries fully charged.

NOTE: When the end panels are illuminated, particularly at full brightness, the charge level may not show a true reading. Lighting may effect charge display.

NOTE: If the ceiling lift has not been operated for more than one minute, both the charge / status indicator and the LCD display screen go into 'sleep' mode and are no longer illuminated. This also applies when the batteries are being charged. Once any command buttons on the hand control are depressed the battery status indicator light and the LCD display screen revert to operational mode again.

⚠ CAUTION

The charge / status indicator will additionally indicate a number of alerts and warnings as follows:

LOW BATTERY WARNING:

If the battery charge is critically low when in sleep mode the charge / status indicator will flash red and, in ambient light conditions, this will be accompanied by an audible beep each time an operating control is depressed. In low light conditions, only the charge / status indicator will flash red.

⚠ WARNING

Low battery status may not allow the lift to complete a patient lift cycle. Batteries should be placed on charge **IMMEDIATELY** - see details in the 'Operator Display Screen' later in this manual.

EMERGENCY STOP:

NOTE: For emergency stop operating instructions refer to the 'Emergency Stop / Electrical Emergency Lower' section of this manual.

When the red emergency stop cord is operated, the charge / status indicator will flash red and this will be accompanied by an audible beep.

The above condition will be accompanied by the notification EMERGENCY STOP on the LCD display screen (See 'Alert Warnings' in the Operator Display Screen section of this manual).

Additionally, the red ring of the 'EMERGENCY STOP / EMERGENCY LOWER' button on the lift unit will be visible.

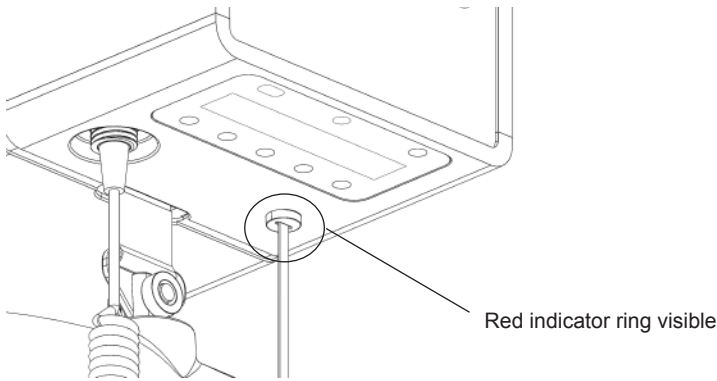
**ELECTRICAL EMERGENCY LOWER:**

NOTE: For electrical emergency lower operating instructions refer to the 'Emergency Stop / Electrical Emergency Lower' section of this manual.

⚠ WARNING

The electrical emergency lowering function must only be used in the event of an emergency.

Continuing the pull on the red emergency stop cord after the emergency stop has activated will cause the electrical emergency lower function to commence.

Whilst the electrical emergency lower is being operated, the charge / status indicator will flash red and this will be accompanied by an audible beep.

The above condition will be accompanied by the notification EMERGENCY LOWER on the LCD display screen (See 'Alert Warnings' in the Operator Display Screen section of this manual).

Additionally, the red ring of the 'EMERGENCY STOP / EMERGENCY LOWER' button on the lift unit will be visible.

NOTE: If electric operating and emergency functions fail, use an alternative method to lower the patient and contact your local Joerns Healthcare authorised service provider.

DRIVE OVERSPEED - CALL SERVICE:

In the event of a serious malfunction with the ceiling lift unit which results in the 'DRIVE OVERSPEED' safety function being activated, the charge / status indicator will flash red and this will be accompanied by an audible beep each time any command buttons on the hand control are depressed. In addition, the notification 'DRIVE OVERSPEED - CALL SERVICE' will be indicated on the LCD display screen. (See 'Alert Warnings' in the Operator Display Screen section of this manual).

The lift will not operate.

⚠ WARNING

Once the overspeed function has been activated the lift will not function. Service / examination is required immediately. Please contact your local Joerns Healthcare service provider to arrange service / examination.

Hand Control

Oxford Elara ceiling lifts are operated by depressing the appropriate command buttons on the hand control as described below:

2-Way Units:

The RAISE and LOWER buttons raise or lower the spreader bar.

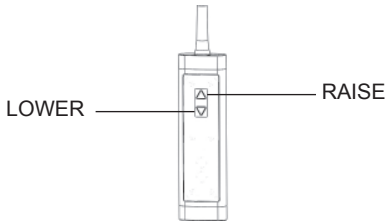

4-Way Units:

- The RAISE and LOWER buttons raise or lower the spreader bar.
- The LEFT and RIGHT buttons traverse the ceiling lift along the rail.
- RETURN TO CHARGE button returns the ceiling lift to the charge station. For details, see 'Rail Systems Fitted with End Charge Stations' section.

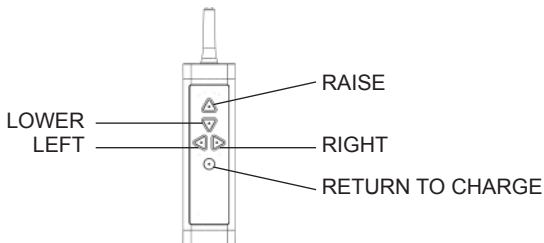

NOTE: When pressing the descent button either on the hand control or the emergency / redundant controls on the lift unit and the spreader bar reaches its lower limit position, the descent travel will automatically halt and the notification TAPE ALL OUT will be displayed in the LCD display screen.

NOTE: The spreader bar must be attached to the lift tape and not supported on a surface in order for the hand control controls to function.

A hook is provided on the back of the hand control to allow storage of the hand control on the spreader bar when not in use.

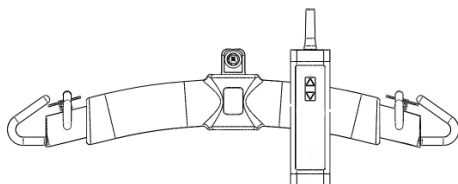

Rail Systems Fitted with End Charge Stations:

Following the raising of the spreader bar to the upper limit, depressing the RETURN TO CHARGE BUTTON commences the automatic traverse of the ceiling lift to the charge station. When the ceiling lift reaches the charge station, traversing automatically ceases.

NOTE: If the spreader bar has not been raised to its upper limit, the return to charge function will not operate.

Additionally, the LCD display screen must be in normal operating mode for the return to charge function to operate. If the display screen is in programming mode the return to charge function will not operate.

NOTE: The patient must be detached from the ceiling lift before depressing the RETURN TO CHARGE BUTTON. If the lift unit senses any load attached to the spreader bar the return to charge function will not operate.

⚠ CAUTION

- For room covering X-Y rail systems and room covering X-Y rail systems incorporating a gate mechanism which are fitted with end charge stations, the traversing rail must be positioned so that it is in contact with the main charge point in the stationary rail prior to pressing the return to charge button.
- For rail systems incorporating either a turntable or a switch track, the lift motor must be manoeuvred so that it is positioned in the rail section incorporating the end charge station prior to pressing the return to charge button.

NOTE: The Elara ceiling lift unit incorporates a safety circuit which halts automatic traverse to the charge station if it has not docked with the charge station within 30 seconds of pressing the return to charge button.

Operator Display Screen

The LCD display screen on your Oxford Elara ceiling lift shows a number of parameter logs and contains a menu system allowing selection and adjustment of various settings.

Additionally, the display screen will indicate a number of alert warnings.

Alert Warnings:

Drive Overspeed - Call Service:

DRIVE OVERSPEED -
CALL SERVICE

This warning will be displayed in the event of a serious malfunction. The lift will not operate.

⚠ WARNING

Once the overspeed function has been activated the lift will not function. Service/examination is required immediately - please contact your local Joerns Healthcare service provider to arrange service/examination.

Emergency Stop:

EMERGENCY STOP

This alert warning will be displayed when the red emergency stop cord has been operated. This will be accompanied by the charge/status indicator flashing red and an audible beep being emitted.

Emergency Lower:

Emergency Lower

This alert warning will be displayed when continuing to pull on the red emergency stop causing the emergency lower function to activate. This will be accompanied by the charge/status indicator flashing red and an audible beep being emitted.

Overload:

OVERLOAD

This warning is displayed if an attempt is made to lift a patient whose weight exceeds the set maximum safe working load of the lift unit.

⚠ WARNING

If the overload warning is displayed, halt the lifting operation immediately.

Low Battery:

LOW BATTERY

This alert warning will be displayed when the battery level falls to a critical level i.e. when only one full lift is achievable.

Battery Depleted:

BATTERY DEPLETED

This alert warning will be displayed following 'LOW BATTERY' alert and one further lift operation is performed.

Alert Warnings (Continued):**Service Overdue:**

SERVICE OVERDUE!

SERVICE INDICATOR - Once the set service period has been reached or exceeded, the 'SERVICE OVERDUE' notification will be displayed each time any of the operating controls buttons are depressed.

⚠ WARNING

Contact your local Joerns Healthcare service provider without delay to arrange service/examination.

Internal Error:

INTERNAL ERROR

This warning will be displayed in the event of an interval electrical malfunction. The lift will not operate.

Service/Examination is required immediately. Please contact your local Joerns Healthcare service provider.

Tape Slack:

Tape Slack

This alert warning is displayed if either the patient or the spreader bar come into contact with a surface i.e. bed or chair, resulting in no load being sensed by the lift unit.

Tape Twisted:

Tape Twisted

This alert warning is displayed if the lift tape becomes twisted during the lift cycle. It may also be displayed if the patient is not lifted perfectly vertically and the lift tape enters the lift unit at an angle.

Tape All Out:

TAPE ALL OUT

This alert warning is displayed when the lower button on the hand control or control panel has been depressed and the lift tape has reached its lower limit of travel.

Top of Travel:

At top of travel

This alert warning is displayed when the raise button on the hand control or control panel has been depressed and the lift tape has reached its upper limit of travel.

Displays, Settings and Menus

1. Standby Mode

In standby mode, the following information is displayed:

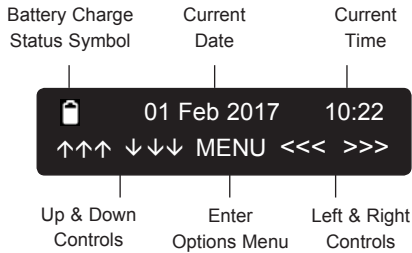

NOTE: If the lift is not placed on charge following 'LOW BATTERY' alert, the LCD display panel will indicate 'BATTERY DEPLETED' and no further lifts will be possible.



BATTERY CHARGE STATUS SYMBOL

The battery charge status symbol indicates the remaining charge when the lift unit is in standby mode. The indicator either shows 1/3rd, 2/3rd or fully charged.

Refer to the 'Charge / Status Indicator' section for more details.

CAUTION

When the battery level falls to a critical level (reaches the point at which only one full lift is achievable) the charge / status indicator will illuminate permanent red (not flashing). This will be accompanied by the alert 'LOW BATTERY' on the LCD display screen, Ensure the lift unit is returned to charge immediately.

2. Sleep Mode

To protect the batteries from unnecessary discharge, the ceiling lift enters sleep mode when no control input is detected after a period of 1 minute. The display will awake when any of the operating buttons are depressed.

3. Menu Map

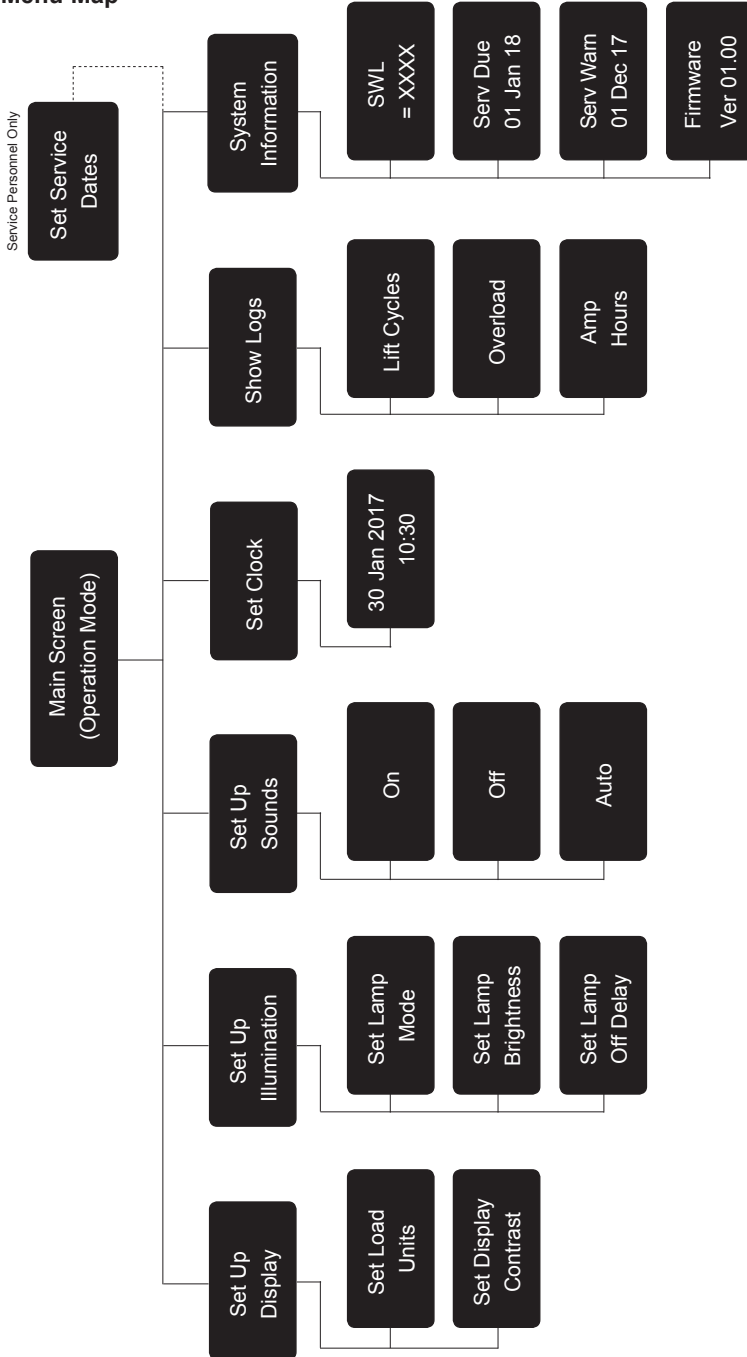

4. Menu Functions

To enter the MAIN MENU depress the button immediately below MENU.

The Main Menu modes are as follows:

Screen 1: Setup Display

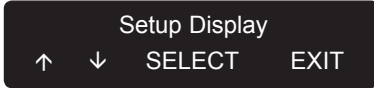

Screen 2: Setup Illumination

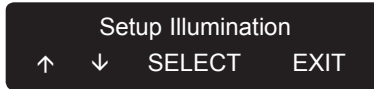

Screen 3: Setup Sounds

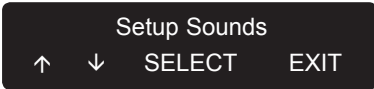

Screen 4: Set Clock

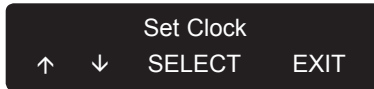

Screen 5: Show Logs

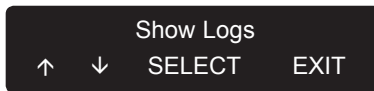

Screen 6: System Information

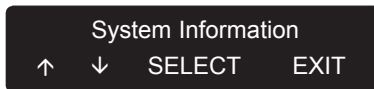

Setting & Viewing Parameters

To enter the MAIN MENU depress the button immediately below MENU.

Use the buttons below the UP and DOWN arrows to scroll through the menu options:

1. Setup Display

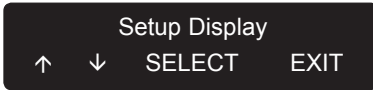

To enter SETUP DISPLAY depress the button below SELECT.

The display screen will show SET DISPLAY CONTRAST.

1a. Set Display Contrast

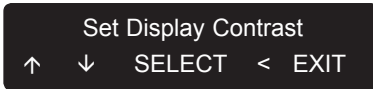

To enter SET DISPLAY CONTRAST depress the button below SELECT.

The display screen shows ADJUST WITH UP/DOWN.

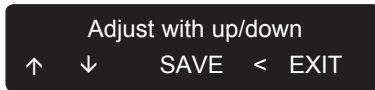

Use the buttons below the UP and DOWN arrows to adjust the display contrast.

Once the desired display contrast is selected, depress the button below SAVE to confirm.

Depress the button below < to return to the SETUP DISPLAY MENU, or depress the < button a second time to return to the main menu. Alternatively, depress the button below EXIT to return to the standby screen.

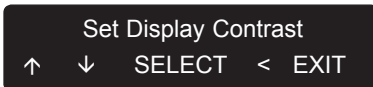

1b. Set Load Units

In the SETUP DISPLAY MENU, use the button below the UP and DOWN arrows to scroll through the menu items until the SET LOAD UNITS screen is displayed.



To enter SET LOAD UNITS, depress the button below SELECT. The screen will display the current selection.

There are two options to choose from:

Option 1: Show load in kg.



Option 2: Show load in pounds.

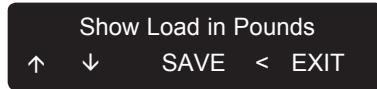

Use the buttons below the UP and DOWN arrows to scroll between the two options.

When the desired load units selection is displayed, depress the button below SAVE.

Once the desired load units has been chosen either depress the button below < once to revert to the SETUP DISPLAY MENU, or depress the < button a second time to revert to the MAIN MENU.

Alternatively, depress the button below EXIT to return to the standby screen.

2. Setup Illumination

In the MAIN MENU, use the buttons below the UP and DOWN arrows to scroll through the menu items until the SETUP ILLUMINATION screen is displayed. To enter the SETUP ILLUMINATION menu, depress the button below SELECT.

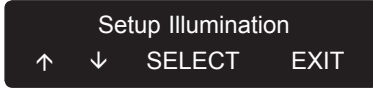

Use the buttons below the UP and DOWN arrows to scroll through the 3 selectable settings.

2a. SET LAMP MODE:

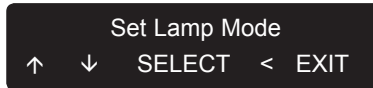

NOTE: The SET LAMP MODE settings allow the selection of when the illumination lamp is lit during normal operation.

Depress the button below SELECT and the current SET LAMP MODE selection will be shown. There are 3 options as follows:

OPTION 1: ON



Selection of ON will result in the illumination lamp being lit at all times during normal operation.

Depress the button below SAVE to select this option or choose an alternative setting by using the buttons below the UP and DOWN arrows to scroll to another option.

OPTION 2: AUTO



Selecting this option will result in the illumination lamp activating ONLY when ambient light levels fall or during periods of darkness.

If AUTO is the required setting, depress the button below SAVE or choose an alternative setting by using the buttons below the UP and DOWN arrows.

OPTION 3: OFF



Selecting this option will result in the illumination lamp being disabled at all times during normal operation. Depress the button below SAVE to confirm this selection.

When the desired option has been saved, either depress the button below < once to revert to the SETUP ILLUMINATION menu or depress the button below < a second time to revert to the MAIN MENU. Alternatively, depress the button below EXIT to return to the standby screen.

2b. SET LAMP OFF DELAY:

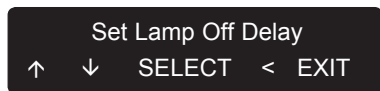

In the SETUP ILLUMINATION menu, use the buttons below the UP and DOWN arrows to scroll through to the SET LAMP OFF DELAY screen.

Enter this function by depressing the button below SELECT. The screen will show the current SET LAMP OFF DELAY setting.

NOTE: The SET LAMP OFF DELAY settings allow selection of the length of time the illumination lamp remains lit in the normal operating mode following the completion of any transfer operation.



Use the buttons below the UP and DOWN arrows to scroll through six possible settings: 10 SECONDS, 20 SECONDS, 30 SECONDS, 1 MINUTE, 2 MINUTES and 5 MINUTES.

When the desired setting is displayed, depress the button below SAVE.

When the desired LAMP OFF DELAY has been saved, either depress the button below < once to revert to the SETUP ILLUMINATION menu or depress the button below < a second time to revert to the MAIN MENU. Alternatively, depress the button below EXIT to return to the standby screen.

2c. SET LAMP BRIGHTNESS:

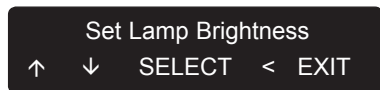

Use the buttons below the UP and DOWN arrows, to scroll through to the SET LAMP BRIGHTNESS screen.

Depress the button below SELECT to access these settings.



Use the buttons below the UP and DOWN arrows to select the brightness to the desired level and press the button below SAVE to store the setting.

When the desired LAMP BRIGHTNESS has been saved, either depress the button below < once to revert to the SETUP ILLUMINATION menu or depress the button below < a second time to revert to the MAIN MENU.

Alternatively, depress the button below EXIT to return to the standby screen.

3. Setup Sounds

In the MAIN MENU, use the buttons below the UP and DOWN arrows to scroll through the menu items until the SETUP SOUNDS screen is displayed. To enter the SET SOUNDS menu, depress the button below SELECT.

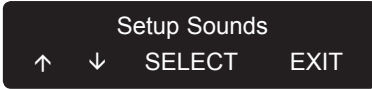

NOTE: The SETUP SOUNDS settings allow the selection of when audible notifications are emitted in the normal operating mode.

Use the buttons below the UP and DOWN arrows to scroll through the options.

There are 3 options to choose from:

OPTION 1: ON



Selection of ON will activate audible notifications during normal operation, e.g. low battery alert.

To confirm this setting, depress the button below SAVE.

If you require an alternative setting, use the buttons below the UP and DOWN arrows to scroll through the options.

OPTION 2: AUTO

Selecting AUTO will result in audible notifications during normal ambient lighting conditions ONLY. When light levels fall, or during periods of darkness, audible notifications are automatically disabled and the status indicator light dims down to offer a more comfortable sleep environment.

To select this setting, depress the button below SAVE.



If you require an alternative setting, use the buttons below the UP and DOWN arrows to scroll to another option.

OPTION 3: OFF

Selecting OFF will result in all audible notifications being silenced during normal operation. To confirm this selection, depress the button below SAVE.



When the desired SETUP SOUNDS setting has been saved, either depress the button below < to revert to the MAIN MENU or depress the button below EXIT to return to the standby screen.

4. Set Clock

In the MAIN MENU, use the buttons below the UP and DOWN arrows to scroll through the menu items until the SET CLOCK screen is displayed. To enter the set clock function, depress the button below SELECT.

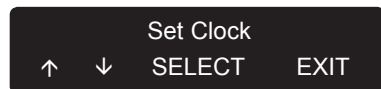

The screen will show the DATE and TIME and the selected parameter will pulse on and off to indicate the value can be adjusted.

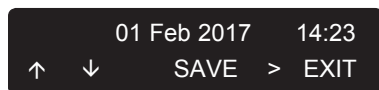

Use the buttons below the UP and DOWN arrows to increase or decrease the selected parameter. When the desired value is shown, use the button below > to select the next parameter and adjust using the buttons below the UP and DOWN arrows.

Continue to select and adjust all parameters to the desired value before depressing the button below SAVE to store them.

Once the updated clock settings have been saved, depress the button below EXIT to return to the standby screen.

5. Show Logs

In the MAIN MENU, use the buttons below the UP and DOWN arrows to scroll through the menu items until the SHOW LOGS screen is displayed. To enter the SHOW LOGS menu, depress the button below SELECT.

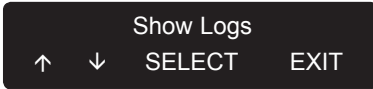

The display screen will now display the total number of LIFT CYCLES performed by the lift.

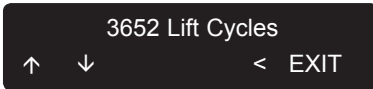

Use the buttons below the UP and DOWN arrows to scroll to AMP HOURS. This screen indicates the total number of Amp/hours drawn by the ceiling lift's motor during use.

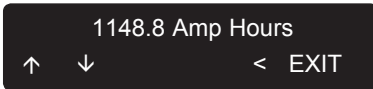

Use the buttons below the UP and DOWN arrows to scroll to OVERLOADS. This screen shows the total number of attempts to lift in excess of the maximum set safe working load.

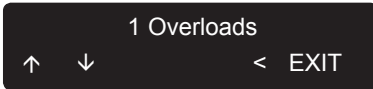

Once all the log parameters have been viewed, depress the button below < once to revert to the MAIN MENU. ALTERNATIVELY, depress the button below EXIT to return to the normal standby screen.

6. System Information

In the MAIN MENU, use the buttons below the UP and DOWN arrows to scroll through the menu items until the SYSTEM INFORMATION screen is displayed.

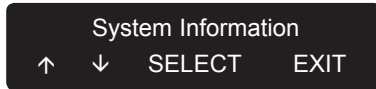

To enter the SYSTEM INFORMATION menu, depress the button below SELECT.

There are 4 SYSTEM INFORMATION screens which display set parameters which are only adjustable by a Joerns Healthcare authorised technician using specialised programming equipment.

These settings CANNOT be altered by the user.

To scroll through the SYSTEM INFORMATION menu, use the buttons below the UP and DOWN arrows.

The information displayed is as follows:

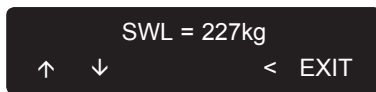

6a. This displays the set maximum safe working load of the lift.



6b. This displays the set date when the next inspection/service is due.



6c. This displays the set date when the notification alert for the service due date will commence being displayed.

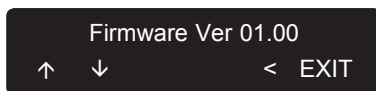

6d. This displays the software revision which the particular lift unit is utilising.

When all the system information has been viewed, depress the button below < to revert to the MAIN MENU.

Alternatively, depress the button below EXIT to return to the standby screen.

7. Set Service Dates

This option is for Joerns Healthcare service providers only.



Lifting & Transferring with the Oxford Elara ceiling lift

WARNING

- **ALWAYS** read the 'Safety Instructions' before using the Oxford Elara ceiling lifts.
- The track **MUST** be installed and modified by an authorised Joerns Healthcare service provider and in accordance with local and regional codes.
- **ALL** tracks **MUST** be closed with rail end stoppers or connected to other closed track components.
- Before use **ENSURE** all rail end stoppers are in place and secured.
- The lift unit should **NEVER** be operated by the patient, only by the caregiver.

Slings

The Oxford Elara ceiling lift has been designed for use with Oxford slings. Therefore it is recommended that Oxford slings are used in conjunction with Oxford Elara ceiling lifts. Oxford slings are available in various sizes from paediatric through to XL and are colour coded to denote the size.

Additionally, a range of more specialised slings are available. Please contact Joerns Healthcare or an authorised Joerns Healthcare service provider for more information.

WARNING

- If you are in any doubt as to the weight of the patient, use a patient scale to confirm their weight to ensure appropriate and compatible sling selection.
- Loop slings are available with or without head support. A range of bathing mesh slings are also available in various sizes, with or without head support.
- Joerns Healthcare recommend a full risk assessment is conducted prior to using any sling to ensure correct fit, function, comfort and safety for the patient.

6-Point Spreader Bar

The Oxford Elara ceiling lift is supplied as standard with the Oxford 6-point spreader bar. The Oxford 6-point spreader bar is fitted with spring loaded sling retainers at either end of the bar which help prevent accidental detachment of the sling loops.

⚠ WARNING

NEVER use a spreader bar where the spring loaded sling retainers have been removed, are not functioning correctly or show signs of damage.

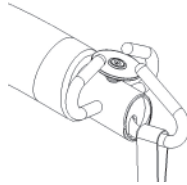

⚠ WARNING

- The 6-point spreader bar is fitted with hooks and spring loaded sling retainers for use with loop attachment slings **ONLY**.
- When attaching a loop sling to the 6-point spreader bar, always ensure the sling attachment loops are located correctly into the spreader bar hooks and are securely retained by the spring loaded sling retainers.

Before Transferring a Patient

⚠ WARNING

- Whenever appropriate, position the patient to face the direction of travel and at all times minimise the distance between the patient and the floor (i.e. maintain chair height). This assures the patient a degree of confidence and dignity throughout the transfer process.
- **BEFORE** commencing the transfer procedure, **ENSURE** the intended route of travel is clear and free from obstruction.
- To ensure maximum comfort, **DO NOT** allow the patient to hold on to the spreader bar during the transfer procedur



Commencing the Transfer

1. Position the patient in the appropriate sling.

NOTE: Refer to the specific sling 'Instructions for Use' to ensure the sling is applied and positioned correctly.

2. Carefully move the ceiling lift into position, directly above the patient.

With the **2-way model**, simply grasp the lift's spreader bar and pull the lift unit along the rail.

With the **4-way model**, use the left and right traversing buttons to manoeuvre the lift unit along the rail.

3. Use the LOWER button on the hand control to lower the spreader bar to a point level with the patient's shoulders (steady the spreader bar with your free hand to avoid the risk of the spreader bar striking the patient's face as a result of sudden movement).

NOTE: If the patient is in the recumbent position, lower the spreader bar down near the patient's chest, then install the sling straps.

WARNING

Hold the ceiling lift spreader bar with one hand at all times when it is near a patient to avoid the risk of collision/injury.

4. Carefully attach the sling straps to the appropriate attachment position as instructed in the sling's 'Instructions for Use'.

WARNING

- **Ensure the sling straps are securely attached to the spreader bar and the sling straps are retained behind the sling retainers before commencing the transfer.**
- **Ensure the sling is not caught on any obstructions (e.g. the arms of a wheelchair).**
- **Ensure the spreader bar is correctly and securely attached to the ceiling lift.**

5. To lift the patient, press the RAISE button.

Elara 2-Way

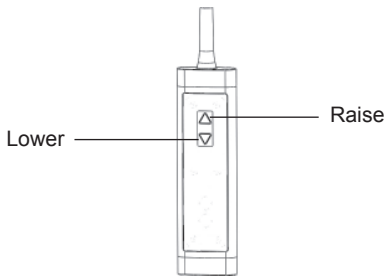

Elara 4-Way

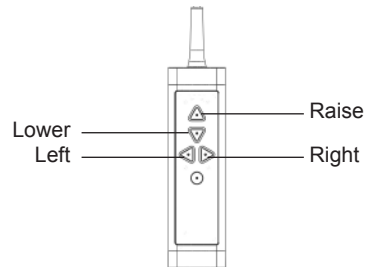

6. Ensure the patient is clear of any obstacles and the path of transfer is not hampered by obstructions. Guide the patient's legs if necessary.
7. When the patient is positioned above the desired point of transfer, press the LOWER button.
8. Use the positioning handles on the rear of the sling (where fitted) to manoeuvre the patient into the desired position when transferring into a chair.
9. Once the patient is properly seated and the sling straps have slackened, detach the sling straps from the spreader bar and remove the sling from around the patient.
10. Raise the spreader bar from the immediate area of the patient.
11. Move the ceiling lift away from the patient.
12. When the transfer is complete, return the ceiling lift to the charging station (if an end of rail charge station is installed). If an in rail charger is fitted, manoeuvre the ceiling lift unit so that it does not cause obstruction and it is out of the immediate vicinity of the patient.
13. Ensure the charge / status indicator on the LCD display screen is pulsing green to verify the charge function is working correctly.

⚠ WARNING

A patient should never be left unattended during a transfer procedure.

Emergency Stop / Electrical Emergency Lower

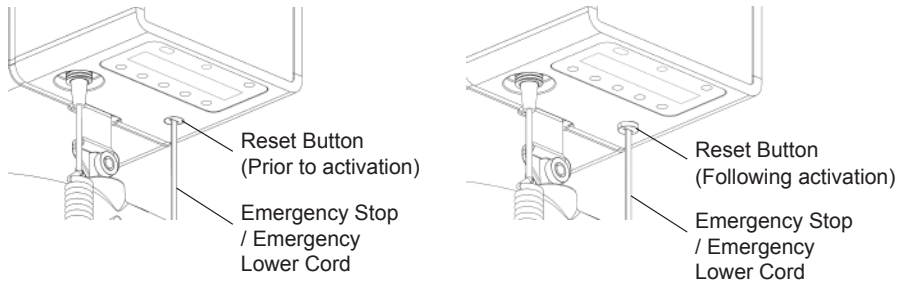

Emergency Stop

The emergency stop function can be activated at any time to halt the functioning of the ceiling lift.

To halt the ceiling lift in an emergency situation, gently pull the red emergency cord until a click is heard and the reset button is protruding from the underside of the ceiling lift cabinet.

NOTE: Continuing to pull on the red emergency stop cord after the emergency stop has activated will cause the electrical emergency lower function to commence (see below).

NOTE: Whilst the emergency stop is in operation the charge / status indicator will flash red and this will be accompanied by an audible beep.

The above condition will be accompanied by the notification 'EMERGENCY STOP' on the LCD display screen (See 'Alert Warnings' in the Operator Display Screen section of this manual).

Additionally, the red ring of the 'EMERGENCY STOP' / EMERGENCY LOWER' will be visible.

To reset the emergency stop function, push the RESET BUTTON upwards so that the face of the button is flush with lower face of the ceiling lift cabinet.

⚠ CAUTION

Do not pull the red emergency cord with excessive force as this could damage the mechanism and the ceiling lift may become inoperable.

NOTE: The hand control will not function until the emergency stop is reset.

⚠ WARNING

Resetting the emergency stop function may necessitate standing on a raised surface to enable the reset to be reached. To avoid the possibility of injury, ensure the raised surface is completely stable prior to stepping on to it. If necessary, the aid of a second person may be enlisted to sustain stability whilst pushing the reset button.

Electrical Emergency Lower

The Oxford Elara ceiling lifts are equipped with an electrical emergency lowering function to facilitate lowering of the patient should the hand control malfunction during a transfer.

NOTE: The electrical emergency lowering function must only be used in the event of an emergency.

At any time whilst the 'ELECTRICAL EMERGENCY LOWER' is being operated the charge / status indicator will flash red and this will be accompanied by an audible beep.

The above condition will be accompanied by the notification 'EMERGENCY LOWER' on the LCD display screen. (See 'Alert Warnings' in the Operator Display Screen section of this manual).

Additionally, the red ring of the 'EMERGENCY STOP' / EMERGENCY LOWER' will be visible.

WARNING

Prior to activating the electrical emergency lowering function, ensure the patient is safely positioned over a suitable stable surface such as a chair or bed.

To activate the electrical emergency lower function, gently pull on the red emergency cord until a click is heard and the RESET BUTTON is protruding from the underside of the ceiling lift cabinet (See image on previous page). Continue to pull the red emergency cord to initiate lowering, ensuring the patient is safely transferred onto a safe and stable surface. Release the emergency cord to halt the lowering function.

CAUTION

Do not pull the red emergency cord with excessive force as this could damage the mechanism and the ceiling lift may become inoperable.

To reset the electrical emergency lowering function, simply push the RESET BUTTON upwards so that the face of the button is flush with the lower face of the ceiling lift cabinet.

WARNING

Resetting the electrical emergency lowering function may necessitate standing on a raised surface to enable the reset button to be reached. To avoid the possibility of injury, ensure the raised surface is completely stable prior to stepping on to it. If necessary, the aid of a second person may be enlisted to sustain stability whilst pushing the reset button.

NOTE: If electric operating and emergency functions fail, use an alternative method to lower the patient and contact your local Joerns Healthcare authorised service provider.

Automatic Emergency Brake

The Oxford Elara ceiling lift is equipped with an automatic emergency brake function to prevent rapid descent of the patient in the unlikely event of a transmission or motor failure.

CAUTION

Once the automatic emergency brake has been activated, the charge / status indicator will flash red and this will be accompanied by an audible beep each time an operating control is depressed.

In addition, the notification 'DRIVE OVERSPEED - CALL SERVICE' will be indicated on the LCD display screen. (See 'Alert Warnings' in the Operator Display Screen section of this manual).

WARNING

- Following an incident where the automatic emergency brake has been deployed, DO NOT attempt to unlock the brake. Use alternative lowering equipment to lower the patient. DO NOT attempt to use either the electrical emergency lowering function or the manual emergency lowering function.
- The emergency brake is intended for single activation. Once deployed, DO NOT use the ceiling lift and contact your authorised Joerns Healthcare service provider.

5. Batteries & Charging

Battery Information

WARNING

DO NOT drop the lift unit. A lift unit that has been dropped may have sustained internal damage that is not visible externally. It may lose its ability to recharge. As a result of internal damage caused when a battery is dropped, the battery charge status indicator may indicate that the battery is fully charged when it actually cannot retain a full charge.

NOTE: After taking delivery of the Oxford Elara lift unit, the batteries should be charged for a minimum period of 8 hours prior to initial use.

Battery Shelf Life

The storage or shelf life of a Sealed Lead Acid (SLA) battery is usually between 12 and 18 months at 20°C starting from a charged condition.

WARNING

NEVER store in a discharged or partially discharged state. Always store in a dry, clean, cool environment and keep fully packaged. If storage of 12 months or longer is required, supplementary charging will be required.

Total Battery Capacity

- 24Vdc - 2.3Ah.
- Provides up to 10 transfers of 227kg from fully charged batteries in the middle 600mm lift zone.

Life cycle of the batteries (number of charging cycles) is mainly dependant on the intensity of discharge in each cycle. The more the battery is discharged, the shorter the life span. The life cycle of the batteries is also related to factors including varying temperatures and rest periods between charge and discharge.

Number of Recharges vs. Depth of Discharge

Batteries should be kept in a fully charged state where possible. Deep discharging on a regular basis without immediate recharge has a detrimental effect on battery life. To prolong the life of your batteries ALWAYS leave them in a fully charged state ready for the next use of your ceiling lift.

NOTE: For installations fitted with an end of rail charge station, battery life will be prolonged by returning the lift to its charge station when not in use. The batteries WILL NOT overcharge.

Joerns Healthcare uses rechargeable Sealed Lead Acid in its ceiling lifts. In contrast to nickel-cadmium batteries, Sealed Lead Acid batteries are not affected by 'memory effect' and therefore, do not require completely discharging prior to recharging.

Number of Lift Cycles vs. Load

The chart below illustrates the relationship between the load lifted and the number of lifts that can be performed with fully charged batteries.

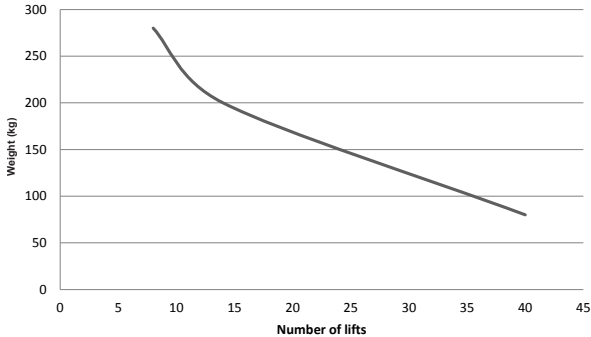

⚠ CAUTION

DO NOT drain the batteries excessively. This will dramatically reduce the expected battery life span.

If the lift is not being used for extended periods of time and consequently not being charged, then the lift should be switched off using the on/off switch on the underside of the lift.

Failure to follow these instructions will result in the batteries being completely discharged and possibly damaged within 48 hours.

If the audible low battery charge signal sounds and the battery charge indicator flashes red, the batteries should be charged without delay.

NOTE: The lift may NOT function until the batteries have been recharged.

Charging the Batteries

⚠ WARNING

- If the battery charger power lead is damaged or the ceiling lift has been dropped, **DO NOT attempt to charge the batteries.**
- **DO NOT forcibly bend the power lead or place heavy objects on it as this may damage the lead and cause fire or electric shock.**
- **DO NOT pour liquid on or near the charger.**

NOTE: Do not place the ceiling lift unit in locations that are:

- Extremely hot
- Dusty or dirty
- Very humid/condensing humidity
- Moving or vibrating

Battery Replacement

The batteries should be replaced when there is a noticeable reduction in the number of transfers that can be performed between charges. If you notice the battery charge status indicator failing to reach full battery condition and an audible beep is heard, refer to the instructions in the 'Trouble Shooting' section in this manual to determine if it is a battery problem.

For battery replacement, contact your local Joerns Healthcare authorised service provider.

CAUTION

DO NOT attempt to use a battery that was not supplied by Joerns Healthcare. Joerns Healthcare batteries are specifically designed to be compatible with Joerns Healthcare charging systems. Attempting to use unauthorised batteries may seriously damage the ceiling lift and/or the charger and may invalidate the warranty.

Verification of Power Source to Charger

If the battery charge status indicator does not pulse green when there are well charged batteries installed in the lift, try the following:

1. Ensure the charger is correctly connected to an AC mains supply (Rail end charger and in rail charging).
2. Ensure the rail charge contacts are clean and not contaminated with dirt, dust or other debris (Rail end charger and in rail charging).
3. Ensure there is good contact between the charge contact rollers of the lift trolley and the contacts of the rail end charger or the rail charge contacts (In-rail charging).

NOTE: When the lift unit charge trolley rollers successfully make contact with the rail end charger or the rail charge contacts (In-rail charging) this will be confirmed by a green pulsing battery charge status indicator on the LCD display screen. After a pre-determined period, the battery charge status indicator and LCD display screen will enter 'sleep' mode and will no longer be visible.

4. Confirm there is power to the AC outlet.
5. Contact your local Joerns Healthcare authorised service dealer.

Charging a 2-Way Model (with End of Rail Charging):

1. Gently pull the ceiling lift to the end of rail charger.
2. Confirm the charge / status indicator pulses green to confirm charging.

NOTE: After a pre-determined period of non-operation of the lift unit, the LCD display screen and battery charge status indicator enter 'sleep mode' and are no longer visible. They revert to operational mode when any operating control is activated.

CAUTION

DO NOT pull the lift unit forcefully back to the end of rail charger as this may damage the charge contacts.

WARNING

ENSURE the patient has been safely removed from the ceiling lift prior to charging.

Charging 4-Way Model (with End of Rail Charging):

1. Use the 'RAISE' button on the hand control to raise the spreader bar until it reaches the upper limit switch (Upward travel automatically halts).
2. Depress the 'Return to Charge' button on the hand control. The ceiling lift will automatically traverse to the end of rail charger.
3. When the ceiling lift reaches the end of rail charger, traverse will automatically halt.
4. Confirm the charge / status indicator is pulsing green to confirm charging.

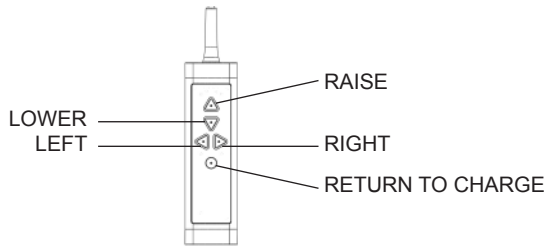
**⚠ WARNING**

ENSURE the patient has been safely removed from the ceiling lift prior to charging.
ENSURE there are no obstructions preventing free travel to the end of rail charger.

Cable Guidance**⚠ WARNING**

Only use an Oxford Elara ceiling lift with the Mascot Type 2240 (24VDC) or Soneil 2401SRM (24VDC) battery chargers.

To protect the cabling from damage, please follow the installation guidance below:

- a) Ensure the charge cable is a safe distance above the floor.
- b) Ensure any cord or cable is protected from contact with moving items. A cord or cable that may touch the floor under any condition of intended use is considered to be exposed to abuse.
- c) The hand control cable is constructed to provide adjustment whilst retaining its length. The cord length is limited so that the unstretched cord does not contact the floor whilst the hand control is in a hanging position.

6. Care & Maintenance Schedule

Joerns Healthcare recommend a thorough inspection and test is carried out at least every six months. The examination and test should be conducted according to the recommendations and procedures below. Joerns Healthcare recommend maintenance, inspection and certified testing is carried out by authorised service providers ONLY.

NOTE: These recommendations are in compliance with the requirements of 1998 No. 2307 Health and Safety: The Lifting Operations and Lifting Equipment Regulations 1998. This is a UK regulation. Outside the UK please check your local requirements.

Preventative Maintenance Schedule

Your Oxford Elara ceiling lift is subject to wear and tear and the following maintenance schedule must be performed at the specified intervals to ensure that the equipment remains within its original manufacturing specifications. The recommended care and maintenance must be carried out in accordance with the preventative maintenance routine as specified below.

In order that the caregiver/user is competent to satisfactorily perform the actions specified in the User Inspection Schedule, it is imperative that they have received adequate training/instruction from a Joerns Healthcare authorised representative or service provider.

Daily checks, a bi-annual thorough examination and an annual service and test will ensure your ceiling lift is kept in optimum condition and safe working order.

Cleaning Instructions

The Elara lift units are only suitable for manual cleaning. Due to the complex internal electronics, the Elara lift units **ARE NOT SUITABLE** for autoclaving.

The lift cabinet panels can be cleaned with ordinary soap on a DAMPENED cloth. **DO NOT** overwet the cloth. Alternatively, use any hard surface disinfectant sparingly applied to a cloth or use proprietary disinfectant wipes. **DO NOT** use bleach, abrasive cleaning products or solvents as these may damage the product.

WARNING

- The patient **MUST** be removed from the Oxford Elara ceiling lift prior to commencing any maintenance routine.
- The maintenance specified in the following schedule is the minimum that the manufacturer recommends. In certain circumstances, more frequent inspections should be carried out. Continuing to use this equipment without performing regular inspections or when a fault is found will seriously compromise the safety of the user/caregiver and the patient. Local regulations and standards may be higher than those of the manufacturer. It is recommended a load test equivalent to the maximum safe working load is conducted by an authorised Joerns Healthcare service provider at least once every 12 months.
NOTE: The LOAD TEST and CERTIFICATION should only be carried out by qualified personnel or a Joerns Healthcare authorised service provider.
- Service, repair and preventative maintenance can be arranged with a Joerns Healthcare authorised service provider. By following the Preventative Maintenance schedule specified in this manual, you can help prevent accidents and minimise repair costs.
- Safety related service and maintenance **MUST** be performed by authorised Joerns Healthcare personnel or a Joerns Healthcare authorised service provider who are competently trained in servicing procedures detailed in both this user manual and the service manual for this product. Failure to meet these requirements could result in personal injuries and/or unsafe equipment.
- Ensure patients are removed from the room during inspection and testing.

User Inspection Schedule

The following checks are to be conducted by the user and/or caregiver:

	Frequency	
	Initially	Before every use
Inspections for Ceiling Lift Unit & Track System		
Inspect for evidence of external damage, missing parts or broken panels.	X	X
Ensure that rail end stoppers are in place and secure.	X	X
Recharge batteries.	X	X
Inspect the lift strap for wear, damage, fraying and loose threads. Ensure stitching is intact.		X
Remain vigilant for excessive movement of track components. (Should such movement be observed, stop use immediately and contact your local Joerns Healthcare authorised service provider).		X
Inspections for Spreader Bar & Slings		
Inspect all sling parts (attachments, fabric, stitching and loops) for signs of wear, damage, discolouration, deterioration or loose threads.		X
Examine the spreader bar attached to the lifting strap for damage or cracks. Ensure all attachments are properly secured and that the sling retainers are present and operate correctly.		X
Ensure spreader bar is securely attached to the lifting tape coupling.		X
Launder the sling in compliance with the instructions on the sling label.	When necessary	

Daily Checklist

WARNING

The patient **MUST** be removed from the ceiling lift prior to commencing maintenance routine.

The following procedures must be performed before each use:

- CHARGE the batteries. Return the lift to the charge station whenever the lift is not in use (End of rail chargers only).
- INSPECT the lift for any signs of damage. If the lift cabinet looks misaligned or there is any damage evident or parts are missing, DO NOT use the lift. Contact your authorised Joerns Healthcare service provider to have the lift serviced/repaired.
- EXAMINE the lifting tape for wear, fraying, cuts, loose threads or chemical damage. If any of these conditions are detected, DO NOT use the lift. Contact your authorised Joerns Healthcare service provider to have the lift serviced/repaired.
- EXAMINE the sling for signs of damage, wear or bleached areas and for frayed, cut or worn straps. If any of these conditions are detected, DO NOT use the sling. Contact your authorised Joerns Healthcare service provider to have the sling replaced.
- EXAMINE the spreader bar for any cracks or damage.
- ENSURE the pin which secures the spreader bar to the lifting strap is secure.

WARNING

Prior to each use, confirm all rail end stops are present and secure.

Cleaning and Inspection

The Oxford Elara ceiling lifts are only suitable for manual cleaning. Due to the complex internal electronics, the Elara lift units **ARE NOT SUITABLE** for autoclaving.

The Oxford Elara ceiling lift panels should be cleaned using a damp cloth, ordinary soap and warm water and disinfecting cleaner. Alternatively, disinfecting wipes supplied impregnated with a 70% solution of isopropyl can be used. DO NOT over wet the cloth.

CAUTION

DO NOT use phenol, chlorine or any other type of solvents or abrasive cleaning products which could damage the finish.

Avoid wetting any of the electrical components.

In order to maintain a smooth rolling surface for the trolley wheels, the inside rolling surface of the track should be cleaned every six months with a damp cloth. Insert the cloth into the track opening and wipe the entire length of the track. Additionally, any debris should be cleaned from the upper surface of the track using a damp cloth.

WARNING

Cleaning the lift unit may necessitate standing on a raised surface to enable the lift unit to be reached. To avoid the possibility of injury, ensure the raised surface is completely stable prior to stepping on to it. If necessary, the aid of a second person may be enlisted to sustain stability whilst cleaning.

Lifting Tape Examination

Inspect the lifting tape for evidence of wear, damage, cuts, fraying, discoloration, chemical attack or loose/damaged stitching. The maximum load the lifting tape can withstand before failure can rapidly reduce and present danger for the patient and/or caregiver.

Joerns Healthcare recommends a thorough examination of the lifting strap is carried out every six months as follows:

1. Completely unwind the lifting tape
2. Inspect the lifting tape for wear, damage, fraying and loose threads and that all stitching is intact.

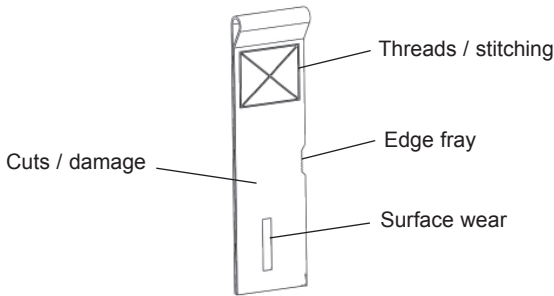

⚠ WARNING

If the lifting tape exhibits any evidence of the defects indicated above, it should be examined by an authorised Joerns Healthcare service provider and replaced if necessary. By continuing to use the ceiling lift without replacing a defective lifting tape, the safety of the patient/caregiver will be greatly compromised and could result in serious injury.

NOTE: The manufacturer recommends the lifting tape is replaced at least every five years. By continuing to use the ceiling lift without replacing the lifting tape, the safety of the patient/caregiver will be greatly compromised and could result in serious injury.

Handling and Storage

NOTE: Even if the ceiling lift is not used, Joerns Healthcare recommends recharging the batteries at least every two weeks to prevent premature aging and/or failure of batteries.

7. Trouble Shooting

WARNING

DO NOT attempt to remove the Oxford Elara cabinet. Only an authorised Joerns Healthcare service dealer is authorised to remove the cabinet. Alterations/repairs performed on an Oxford Elara ceiling lift by non-authorized persons may cause serious injury.

Problem	Investigation / Remedy
The lift starts and stops repeatedly.	If the maximum safe working load has been exceeded, the SWL overload protection will activate and an "OVERLOAD" message will be indicated on the LCD display screen.
During the attempted lift, the charge/status indicator illuminates red (not flashing) and this is accompanied by the alert 'LOW BATTERY' on the LCD display screen.	The battery charge is critically low and requires charging immediately.
During the attempted lift, the charge/status indicator illuminates red (not flashing) and this is accompanied by the alert 'BATTERY DEPLETED' on the LCD display screen.	The battery charge is critically low and requires charging immediately.
The charge/status indicator is not flashing green when the lift is on charge and in operating mode (not in sleep mode).	Check the charger is connected to the mains supply. Does the mains supply have power? Check the condition of the fuse in the mains plug. If necessary replace the fuse. If these actions are unsuccessful, contact your Joerns Healthcare authorised service provider to arrange inspection/repair.
When the battery charge status symbol on the LCD display screen indicates 'FULL BATTERY' does the charge/status indicator illuminate red (not flashing) following a small number of lifts.	Replace the batteries with new ones. Contact your Joerns Healthcare authorised service provider to arrange battery replacement.
The lift does not operate when the buttons on the hand control are depressed.	Is the lift turned on?
	Is the emergency stop activated? The LCD display screen will indicate 'EMERGENCY STOP'. Reset the emergency stop button so it is no longer protruding from the lift cabinet
	Is the hand control correctly connected?
	Slide the lift unit to the charge station (end of track charger variant). Does the battery/charge status indicator pulse green?
	Is the spreader bar resting on a surface? The lift must sense the weight of the spreader bar on the end of the lift tape in order to function correctly. Is the LCD display screen indicating a 'TAPE SLACK' message?
	Is the lift tape twisted where it enters the cabinet? Is the LCD display screen indicating 'TAPE TWISTED' message?
	If the unit will still not operate after testing the above, contact your Joerns Healthcare authorised service provider to arrange inspection/repair.
	The charge/status indicator illuminates red (not flashing) and the alert 'BATTERY DEPLETED' is displayed on the LCD display screen. The battery charge is critically low and requires charging immediately.
	The alert 'INTERNAL ERROR' is displayed on the LCD display screen. Contact your authorised Joerns Healthcare service provider to arrange inspection/repair.

Problem	Investigation / Remedy
Following an overnight charge, the battery charge status symbol on the LCD display screen does not indicate FULL BATTERY symbol.	Check the charger is connected to the mains supply. Does the mains supply have power? Is the charge/status indicator flashing green when the lift unit is on charge and in operating mode (not in sleep mode)? if not contact your local approved Joerns Healthcare service provider for inspection/servicing.

8. Technical Specifications

Lifting Capacity - Oxford Elara 227 (Maximum SWL)..... 227kg

Lifting Capacity - Oxford Elara 284 (Maximum SWL)..... 284kg

General:

Housing Length	315mm
Housing Width	210mm
Housing Depth.....	179mm
Lifting Range	2200mm
Lifting Speed (SWL - 227kg (500lb)).....	3.4cm/sec
Lifting Speed (SWL - 284kg (626lb)).....	3.0cm/sec
Lifting Speed 100kg (220lbs)	3.2cm/sec
Lifting Speed (without load).....	4.3cm/sec
Lifts Per Charge 100kg	35
Lifts Per Charge 80kg	40

Weights:

Weight (Excluding Spreader Bar).....	12kg
Spreader Bar	4.4kg
Hand Control	1.5kg

Electrical:

WARNING

NOTE: ONLY operate the Oxford Elara ceiling lift with the Joerns Healthcare specified battery charger. The charger is part of the medical device system.

Mascot Type 2240 Charger:

Rated Input.....	110-240VAC, 50-60Hz max 0.35A*
Rated Output	Max 29.4VDC - 0.5A (Orange/Red)
.....	Ready/Standby 27.4VDC (Green)
Classification	Class II Electrical Equipment
Compliance.....	Meets requirements of IEC 60601-1

Soneil 2401SRM Charger:

Rated Input.....	110-240VAC, 50/60Hz 0.4A*
Rated Output	Max 28.8VDC - 0.5A (Orange)
.....	Ready/Standby 27.6VDC (Green)
Classification	Class II Electrical Equipment
Compliance.....	Meets requirements of IEC 60601-1

* The charger is rated at 100-240V by the manufacturer but for compliance with the necessary standards it has to be restricted to 110-240V.

Oxford Elara Ceiling Lift:

Internally Powered.....24VDC Sealed lead acid (SLA) batteries
 Duty Cycle.....Maximum 2 minutes operation/minimum 18 minutes pause

Degree of Protection Against Electric Shock:

Sling.....Type BF applied part (no electrical connection)

Environmental:

Noise Level for Raising or Lowering63DbA without load

Ingress Protection:

HandsetIPX4

Charger.....IP4X

HoistNot protected

Operational Conditions:

Ambient Temperature Range +5°C to +40°C (+41°F to +104°F)

Relative Humidity Range 15% to 93% non-condensing

Atmospheric Pressure Range 700 hPa to 1060 hPa

 WARNING

This equipment is not suitable for use in the presence of flammable Anaesthetic mixtures with air or oxygen, or with nitrous oxide.

Recycling Information

Packaging..... Cardboard - recyclable

Other Materials..... In accordance with local directives and facilities

Ceiling Lift Unit Contact your local authorised Joerns Healthcare service provider

Dimensions:

* This dimension will vary dependant on rail variant and rail suspension height.

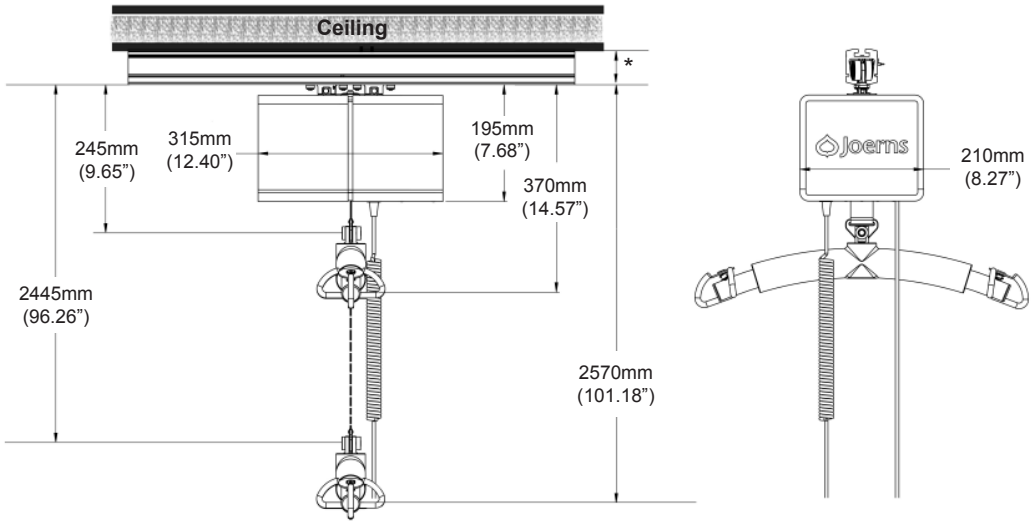

Electromagnetic Compliance:

⚠ WARNING

Wireless communication equipment such as wireless home network devices, mobile phones, cordless telephones and their base stations etc. can affect the Oxford Elara ceiling lifts and should be kept a minimum of 2340mm away from the lift unit. Cables from potentially strong sources of electromagnetic fields should not be placed near the lift unit.

Guidance and manufacturer's declaration-electromagnetic emissions		
The Oxford Elara is intended for use in the electromagnetic environment specified below. The customer or the user of the Oxford Elara should ensure that it is used in such an environment.		
Emission Test	Compliance	Electromagnetic Environment Guidance
RF emissions CISPR11.	Group 1.	The Oxford Elara uses RF energy only for its internal function. Therefore, its RF emissions are very low and are not likely to cause any interference in nearby electronic equipment.
RF emissions CISPR11.	Class B.	The Oxford Elara is suitable for use in all establishments, including domestic establishments and those directly connected to the public low-voltage power supply network that supplies building used for domestic purposes.
Harmonic emissions IEC 61000-3-2.	Not applicable.	
Voltage fluctuations/flicker emissions IEC 61000-3-3.	Not applicable.	

If the Oxford Elara ceiling lift affects or is affected by other equipment, either the Oxford Elara ceiling lift or the equipment should be moved away.

Guidance and manufacturer's declaration-electromagnetic immunity			
The Oxford Elara ceiling lifts are intended for use in the electromagnetic environment specified below. The customer or the user of the Oxford Elara should ensure that it is used in such an environment.			
Immunity Test	IEC 60601 Test Level	Compliance Level	Electromagnetic Environment Guidance
Electrostatic discharge (ESD) IEC 61000-4-2.	± 6kV contact. ± 8kV air.	± 6kV contact. ± 8kV air.	Floors should be wood, concrete or ceramic tile. If floors are covered with synthetic material, the relative humidity should be at least 30%.
Electrical fast transient/burst IEC61000-4-4.	± 2kV for power supply lines. ± 1kV for input/output lines.	Not applicable. Not applicable.	Mains power quality should be that of a typical commercial or hospital environment.
Surge IEC 61000-4-5.	± 1kV line(s) to line(s). ± 2kV line(s) to earth.	Not applicable. Not applicable.	Mains power quality should be that of a typical commercial or hospital environment.
Mains power quality should be that of a typical commercial or hospital environment.	<5% UT(>95% dip in UT) for 0.5 cycle. 40% UT(60% dip in UT) for 5 cycles. 70% UT(30% dip in UT) for 25 cycles. <5% UT(>95% dip in UT) for 5 cycles.	Not applicable. Not applicable . Not applicable. Not applicable.	Mains power quality should be that of a typical commercial or hospital environment. If the user of the Oxford Elara requires continued operation during power mains interruptions, it is recommended that the Oxford Elara be powered from an uninterruptable power supply or battery.
Power frequency (50/60 Hz) magnetic field IEC 61000-4-8.	3 A/m.	3 A/m.	The Oxford Elara power frequency magnetic fields should be at levels characteristic of a typical location in a typical commercial or hospital environment.
NOTE: UT is the a.c. mains voltage prior to application of the test level.			

Guidance and manufacturer's declaration-electromagnetic immunity			
The Oxford Elara lifts are intended for use in the electromagnetic environment specified below. The customer or the user of the Oxford Elara should assure that it is used in such an environment.			
Immunity test	IEC 60601 test level	Compliance level	Electromagnetic environment-guidance
Conducted RF. IEC 61000-4-6.	3 Vrms. 150 KHz to 80 MHz.	Not applicable.	Portable and mobile RF communications equipment should be used no closer to any part of the Oxford Elara including cables, than the recommended separation distance calculated from the equation applicable to the frequency of the transmitter. Recommended separation distance: $d = 1.2 \sqrt{P}$ $d = 1.2 \sqrt{P}$ 80MHz to 800 MHz. $d = 2.3 \sqrt{P}$ 800MHz to 2.5 GHz.
Radiated RF. IEC 61000-4-3.	3 V/m. 80MHz to 2.5 GHz.	3 V/m.	Where P is the maximum output power rating of the transmitter in watts (W) according to the transmitter manufacturer and d is the recommended separation distance in metres (m). Field strengths from fixed RF transmitters, as determined by an electromagnetic site survey, ^a should be less than the compliance level in each frequency range ^b . Interference may occur in the vicinity of equipment marked with the following symbol: 

NOTE 1 At 80 MHz and 800 MHz, the higher frequency range applies.

NOTE 2 These guidelines may not apply in all situations. Electromagnetic propagation is affected by absorption and reflection from structures, objects and people.

a Field strengths from fixed transmitters, such as base stations for radio (cellular/cordless) telephones and land mobile radios, amateur radio, AM and FM radio broadcast and TV broadcast cannot be predicted theoretically with accuracy. To assess the electromagnetic environment due to fixed RF transmitters, an electromagnetic site survey should be considered. If the measured field strength in the location in which the Oxford Elara is used exceeds the applicable RF compliance level above, the Oxford Elara should be observed to verify normal operation. If abnormal performance is observed, additional measures may be necessary, such as re-orienting or relocating the Oxford Elara.

b Over the frequency range 150 kHz to 80 MHz, field strengths should be less than 3 V/m.

KEY SYMBOLS AND DEFINITIONS:

The following symbols are used on the charger, ceiling lift unit and peripheral items:



Type BF applied part, no electrical connection.

NOTE: The sling is identified as the applied part.



Follow instructions for use.



The disposal of electronics should not be mixed with general household waste.



Operating instructions.



For indoor use.

SWL

Safe Working Load represents the maximum load the lift is rated for safe operation.



General warning sign.

| : 2 min
0 : 18 min

Duty Cycle

(2 minute operation 18 minute pause)



This symbol is accompanied by a date to indicate the date of manufacture and by the address of the manufacturer.



2 Way Control



Class II equipment



4 Way Control

AC

Alternating current.

IPX4

Protected against water spray from any direction

DC

Direct current.

9. Warranty

Joerns Healthcare has an established network of authorised distributors and service agents who will be pleased to handle all of your purchasing, warranty, repair and maintenance enquiries. It is recommended that our products are commissioned by your authorised distributor or service agent.

The distributor or service agent operates the warranty programme, so it is important to keep a record of their name, address and telephone number so they can be contacted should any problem arise. If you are in any doubt as to where your lift was purchased, Joerns Healthcare can trace the supplier if you quote the serial number of the lift.

All warranty claims are subject to the correct use and maintenance in accordance with the user instruction manual provided with each lift. Damage caused by use in unsuitable environmental conditions or failure to maintain the product in accordance with user and service instructions is not covered. Your statutory rights remain unaffected.

REMEMBER: Contact your authorised distributor or service agent for purchases, repairs, servicing and certified maintenance.

Your distributor:

