

K-chair

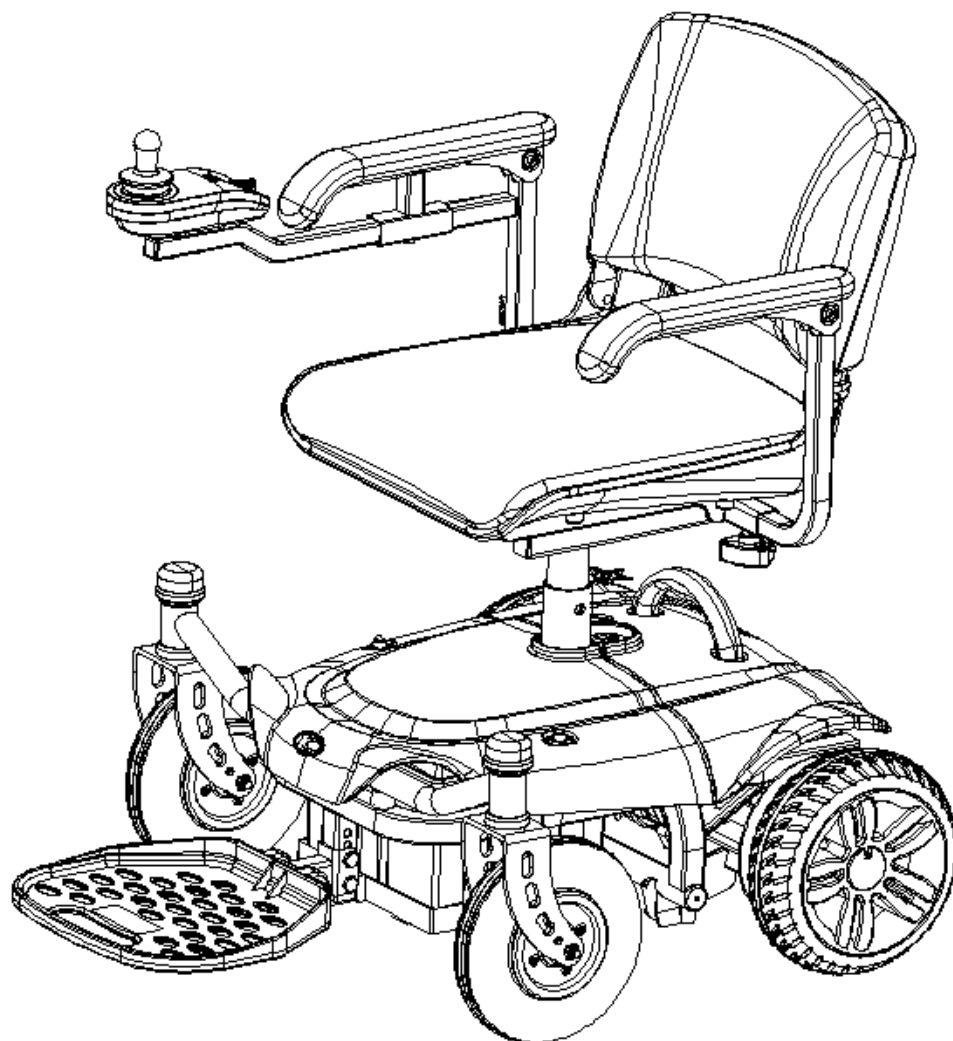

Contents

BEFORE DRIVING	1
1.INSTRUCTIONS FOR USE	1
2.INTRODUCTION	2
3.GENERAL SAFETY INFORMATION	3
4.GETTING TO KNOW YOUR WHEELCHAIR	14
5.PRODUCT SPECIFICATIONS	16
6.PUSHING AND TRANSPORTING THE WHEELCHAIR ...	17
6.1 <i>Parts</i>	18
6.2 <i>To Disassemble:</i>	19
6.3 <i>ASSEMBLY</i>	20
7.ADJUSTING THE WHEELCHAIR	22
7.1 <i>SWIVELING THE SEAT TO GET ON AND OFF</i>	22
7.2 <i>TURNING THE SEAT</i>	23
OPERATING	24
8.OPERATING THE WHEELCHAIR	24
8.1 <i>POWERING ON/OFF</i>	25
8.2 <i>ADJUSTING THE SPEED</i>	26
8.3 <i>DRIVING FORWARDS AND BACKWARDS</i>	27
8.4 <i>OVERLOAD PROTECTION</i>	28
8.5 <i>SWITCHING ON THE HORN</i>	28
9.BATTERY AND CHARGING	29
9.1 <i>BATTERY STATUS DISPLAY</i>	30
9.2 <i>CHARGING THE BATTERIES</i>	31
9.3 <i>AFTER CHARGING</i>	34
9.4 <i>ERROR CODE</i>	34
10.EMI	36

BEFORE DRIVING

1. INSTRUCTIONS FOR USE

The wheelchair is a motorised electric wheelchair for use indoors & Outdoors on flat surfaces such as pavements, roads, parking lots and drive ways.

It is intended to increase the mobility of persons who are both physically and mentally capable of correctly assessing driving situations and reacting correspondingly to them at any time.



Uses:

DO NOT operate this equipment without first reading and understanding the user manual. If you are unable to understand the warnings, cautions, and instructions, contact your retailer; otherwise injury or damage may result. Procedures other than those described in this manual **MUST** be performed by a qualified technician.

We reserve the right to make changes and update this manual without prior notice.

Copyright © 2013 Kymco HealthCare Inc.

This powered wheelchair meets all of the requirements of ISO 7176-9:2009

2. INTRODUCTION

DEAR CUSTOMER

With your k-chair, you have now purchased a product, which has been manufactured in accordance with the newest technical capabilities and based on the highest operating user comfort.

We have placed great value on the simplest possible operation and long service life in both construction and materials selection.

A large variety of useful accessories rounds off our range in addition to the wheelchair.

This Operating Manual assumes that the suitability of the user for wheelchair usage has been discussed with a doctor, therapist and /or dealer before operation.

The operating manual will help you get to know the function of your wheelchair and, in addition, describes

- operation
- care and maintenance
- repair

The manual has been drawn up using information available at the time of printing with regard to construction and operation of the wheelchair.

We reserve the right to make changes due to technical improvements.

If you have any other questions about this wheelchair please contact your retailer or supplier.

GENERAL SAFETY INFORMATION

3. GENERAL SAFETY INFORMATION

 **WARNING!** Before you operate your wheelchair, please read and understand all information provided with your wheelchair for your safety. As operating any vehicle, only drive with full alertness to ensure safety.

 **WARNING!** Please observe the warnings below to avoid any damage or injury resulting from improper use of your wheelchair. The wheelchair user is responsible for taking proper safety measures. We will not be held liable for personal injury and/ or product damage resulting from improper use of the wheelchair. Obey all local pedestrian traffic rules. It may be difficult for others to see you when you are seated on your wheelchair. Wait until your path is clear of traffic, and then proceed with extreme caution. Use of safety equipment such as reflectors/reflective clothing, and safety flags may be useful for your safety.

 **WARNING!** Please consult your healthcare professionals routinely to ensure there are no health or physical conditions that may limit or impair your ability to safely operate your wheelchair.

 **WARNING!** Consult your physician if you are taking prescription or over-the-counter medications or if you have any physical limitations. Some medications and physical limitations may impair your ability to safely operate your wheelchair.

 **WARNING!** Do not operate your wheelchair while you are under the influence of alcohol, as this may impair your ability to safely operate your wheelchair.

 **WARNING!** Every wheelchair is different. Take the time to learn the feel of this wheelchair before you begin driving.

 **WARNING!** BE AWARE that becoming a capable and safe wheelchair operator will take time and practice.

GENERAL SAFETY INFORMATION

 **WARNING!** Anti-tippers substantially reduce your risk of falling over backwards, which can cause serious injury.

 **WARNING!** Have someone help you practice bending and reaching on the wheelchair and transferring to and from the wheelchair until you learn how to do it safely.

 **WARNING!** NEVER try a new manoeuvre on your own.

 **WARNING!** Get to know the areas where you plan to use your wheelchair. Look for hazards and learn how to avoid them.

 **WARNING!** Do not use the wheelchair other than for its original purpose. Avoid any use, such as weight training, sports and athletics, hauling, moving or towing anything, that may lead to safety hazards and undue stress on the wheelchair.

 **WARNING!** Your wheelchair is designed for one passenger only. Do not carry passengers on your wheelchair.

 **WARNING!** Always use the seatbelt to safely operate your wheelchair; make sure it is fastened securely. This will reduce the possibility of a fall from the wheelchair and will ensure that the seatbelt cannot get caught in the tires while driving.

 **WARNING!** Inspect the seatbelt for loose parts or damage before each use of the wheelchair. If damaged, contact your approved service provider for maintenance and repair immediately. Do not operate your wheelchair with a faulty seatbelt.

 **WARNING!** We strongly recommend that you do not smoke cigarettes while seated on your wheelchair. You must adhere to the following safety guidelines if you decide to smoke cigarettes while seated in your wheelchair: Do not leave lit cigarettes unattended.

GENERAL SAFETY INFORMATION

Keep ashtrays a safe distance from the seat cushions. Always make sure cigarettes are completely extinguished before disposal.

 **WARNING!** Do not modify your wheelchair in any way by yourself. For any accessories, please contact your approved service provider for installation by an authorised service technician.

 **WARNING!** The addition of accessories to your wheelchair may change certain specifications such as overall weight, size, and/or center of gravity of your wheelchair. Please note how some of the changes may damage objects around you.

 **WARNING!** Do not change your seating configuration. Please contact your approved service provider for any adjustments.

 **WARNING!** Do not use any replacements on your wheelchair, such as a different seating system. Only use the seating system that has been tested for safety and provided by the manufacturer.

 **WARNING!** Do not remove the seat cushion provided with the wheelchair. Do not place any cushion, padding, or pillow on the seat. This could create an unstable seat position, resulting in a fall from the wheelchair.

 **WARNING!** Exercise extreme caution when using oxygen in close proximity to electrical circuits and combustible materials. Contact your oxygen provider for information on using oxygen safely.

 **WARNING!** Do not change the settings of the controller. Please call your approved service provider to check the controller settings on your wheelchair every six to twelve months. Please contact your approved service provider if you notice any change in your ability to control your wheelchair.

 **WARNING!** Do not use your wheelchair in "freewheel" mode without an attendant present.

GENERAL SAFETY INFORMATION

 **WARNING!** Do not place the wheelchair in “freewheel” mode while the unit is powered up. Always power off the wheelchair and remove the key from the key switch before engaging or disengaging “freewheel” mode.

 **WARNING!** To prevent the wheelchair from rolling uncontrollably on its own, never place the wheelchair in “freewheel” mode on any incline or decline.

 **WARNING!** If you anticipate being seated in a stationary position for an extended period of time, turn off the power to the wheelchair. This will prevent unexpected or unintended wheelchair movement.

 **WARNING!** Avoid using any accessories that may interfere with the operation of the throttle Joystick lever, which may result in unintended or uncontrolled movement of the wheelchair.

 **WARNING!** Keep yourself, clothing, and all other objects away from the wheels while driving. Do not allow any objects to drag behind the wheelchair when driving. Loose-fitting clothing or other objects can get caught in the tires and/or the running gear.

 **WARNING!** Possible strangulation hazard! Be aware that clothing, lanyards, necklaces, other jewelry, purses, and other accessories worn or carried by you while you are seated on or operating the wheelchair may get caught around the armrests or joystick control lever.

 **WARNING!** Do not connect any device to the wheelchair’s electrical system or use the wheelchair batteries to power anything else other than your wheelchair.

 **WARNING!** Always grasp the connector itself when disconnecting the harness to prevent wire damage. Do not pull on electrical harnesses directly.

 **WARNING!** Keep all charger power cord connectors clean, dry and away from sources of dampness at all times to prevent damage to the

GENERAL SAFETY INFORMATION

electrical system and/or personal injury. Check any actuators for loose, worn, or damaged items and have any damaged wires replaced immediately.

 **WARNING!** Check electrical components frequently for signs of corrosion and have them replaced as necessary.

 **WARNING!** Always secure the wheelchair and its batteries when it is being transported. Batteries should be secured in an upright position and protective caps should be secured on the battery terminals. Do not transport the wheelchair and/or batteries with any flammable or combustible items.

 **WARNING!** Do not handle batteries without supervision by an authorised service technician. Battery posts, terminals, and related accessories contain lead and lead compounds and can be hazardous. wheelchair batteries are heavy. Anyone lifting wheelchair batteries should use proper lifting techniques and avoid lifting beyond his/her capacity.

 **WARNING!** NEVER attempt to recharge the batteries by attaching cables directly to the battery terminals or clamps.

 **WARNING!** DO NOT attempt to recharge the batteries and operate the equipment at the same time.

 **WARNING!** Always use two batteries of the exact same type, chemistry, and amp-hour (Ah) capacity. Follow the specifications provided in the user manual for battery type and capacities.

 **WARNING!** Do not mix old and new batteries. Always replace both batteries at the same time.

 **WARNING!** Only sealed batteries that meet DOT CFR173.159 should be used in the wheelchair. Replacement batteries should be obtained directly from an authorised provider to ensure conformity, fit, and function.

GENERAL SAFETY INFORMATION

 **WARNING!** Always protect the batteries from freezing; for those living in cold climates, make sure you store the wheelchair properly. Never charge a frozen battery. Charging a frozen battery may result in damage to the battery.

 **WARNING!** Do not remove fuses/overload trips from the circuitry. If they appear damaged, contact your authorised provider for service.

 **WARNING!** Do not operate the wheelchair with depleted batteries; you could be stranded.

 **WARNING!** Reduce your speed, do not make any sharp turns and maintain a stable center of gravity while turning/cornering. To prevent tipping, avoid shifting your weight in the opposite direction of the turn.

 **WARNING!** While driving up inclines or door thresholds etc., drive your wheelchair straight on with the wheels perpendicular to the incline and/or threshold; both front wheels should contact at the same time. To reduce the possibility of a fall, do not drive at an angle; do not get one wheel or side of the wheelchair on the incline/threshold first. Always exercise extreme caution when negotiating an incline.

 **WARNING!** Do not travel up or down potentially hazardous surfaces and/or inclines, including but not limited to areas covered with snow, ice, cut grass, or wet leaves.

 **WARNING!** When climbing an incline, try to keep the wheelchair moving. If stopping is necessary, start up again slowly and then accelerate with caution.

 **WARNING!** When descending an incline, use the slowest speed possible. If the descent is faster than you desire, release the joystick control lever to stop the wheelchair. Then press the joystick control lever slightly to control the speed of your descent.

GENERAL SAFETY INFORMATION

 **WARNING!** The maximum recommended incline angles (see specifications) are tested in a controlled environment. Your wheelchair's ability to climb up inclines is affected by your weight, speed and the angle you approach the incline among other factors.

 **WARNING!** Only drive backwards on a flat surface. When driving backwards, operate your wheelchair at a lower and even speed. Stop often and check to make sure your path is clear of obstacles. To prevent tipping, do not travel down an incline or ramp backwards.

 **WARNING!** To prevent tipping, do not attempt to negotiate inclines/declines and/or obstacles with your seat in a reclined position (if recline option fitted).

 **WARNING!** To avoid overloading the wheelchair and potential tipping, never carry anything on your wheelchair, footplate or seating area.

 **WARNING!** Avoid any change of position or movement that may change your center of gravity while sitting on the wheelchair. This may cause your wheelchair to tip.

 **WARNING!** A drop-off (as small as 2 inches) at the bottom of a slope can stop a front wheel and cause the wheelchair to tip forward.

 **WARNING!** Never reach or lean or shift your weight sideways or rise up off the seat if possible.

 **WARNING!** Never reach or lean, if you must move forward in your seat always keep your buttocks in contact with the backrest.

 **WARNING!** Never try to pick up an object from the floor by reaching down between your knees.

 **WARNING!** Never reach or lean over the top of the seat back. This may damage the backrest and cause you to fall.

GENERAL SAFETY INFORMATION

 **WARNING!** Do not use the armrests for any weight bearing purposes. Such use may cause the wheelchair to tip, which may result in a fall from the wheelchair and personal injury.

 **WARNING!** Do not put all of your weight on one side of the wheelchair, such use may cause the wheelchair to tip.

 **WARNING!** Even though your wheelchair may be capable of handling greater obstacles, we recommend that you do not attempt to negotiate a curb that has a height greater than 2 in. (5 cm). Doing so could cause instability in your wheelchair. Riding over curbs or obstacles can cause tipping and serious bodily harm. If you have any doubt that you can safely cross any curb or obstacle, **ALWAYS ASK FOR HELP.** Be aware of your riding skills and personal limitations. You may need to remove or cover threshold strips between rooms and install a ramp at entry or exit doors.

 **WARNING!** Do not try to climb an obstacle when on an incline.

 **WARNING!** Do not drive over an obstacle with just one wheel.

 **WARNING!** Do not drive on uneven terrain and/or soft surfaces.

 **WARNING!** Do not drive near tall grass that can entangle the running gear.

 **WARNING!** Avoid driving on loosely packed gravel and/or sandy surfaces.

 **WARNING!** Do not use your wheelchair on or near railroad tracks or crossings.

 **WARNING!** Do not ride your wheelchair along the edges of streams, lakes, or the ocean. Never use your wheelchair to cross waterways.

 **WARNING!** If you feel unsure about a driving surface, avoid that surface.

GENERAL SAFETY INFORMATION



WARNING! Do not expose your wheelchair to open flames.



WARNING! Keep your wheelchair in a dry and clean condition. Never take your wheelchair into a shower, tub, pool, or sauna. Rain, snow, salt, mist/spray conditions, and icy/slippery surfaces can damage the wheelchair components or cause the wheelchair frame to prematurely rust.



WARNING! Avoid prolonged exposure to heat or cold; it may affect the temperature of upholstered and non-upholstered components on the wheelchair. Exercise caution when using your wheelchair in extremely hot or cold conditions.



WARNING! Do not tow your wheelchair. Towing may exceed the maximum speed threshold, resulting in damage to critical components of the wheelchair.



WARNING! Use extreme caution when it is necessary to move an unoccupied wheelchair up or down stairs. Remove the seat, batteries, and any accessories before attempting the transfer. Use proper lifting techniques and use only solid, non-removable frame components to lift the wheelchair with multiple physically capable attendants. Do not lift or move your wheelchair or seating system by grasping or holding onto any of its removable parts, including the armrest(s), seatback, or shrouds.



WARNING! When your wheelchair is used with any type of lift/elevation devices, always turn off the power of the wheelchair; make sure the wheelchair is not in "freewheel" mode and do NOT sit on your wheelchair. Failure to follow this may result in unintended movement and personal injury or product damage.

GENERAL SAFETY INFORMATION



WARNING! Never use your wheelchair to negotiate stairs or escalators.



WARNING! Never sit on the wheelchair while it is in a moving vehicle.



WARNING! Never transport the wheelchair in the front seat of a vehicle. It may shift and interfere with the driver.



WARNING! Always secure the wheelchair so that it cannot roll or shift.



WARNING! Refer to the tire pressure (if air tires fitted) recommended in your user manual to ensure best control. Only inflate the tires using a regulated, low-pressure air source with an available pressure gauge. Do not underinflate or overinflate your tires. Low pressures may result in loss of control, and high pressures may result in the rupturing of tires. Check your tire pressure at least once a week.



WARNING! Should the fittings on your seating system become loose, please call your approved service provider.

WARNING! Replace worn or damaged upholstery immediately to reduce the risk of fire hazard.



WARNING! Be aware that washing of upholstered items may reduce the fabric's resistance to flammability.

GENERAL SAFETY INFORMATION



WARNING! Radio wave sources, such as radio stations, TV stations, amateur radio (HAM) transmitters, two-way radios, and cellular phones, can affect motorised wheelchair control. Following the warnings listed below should reduce the chance of unintended brake release or motorised wheelchair movement, which could result in serious injury.

- 1) Do not turn ON hand-held personal communication devices, such as citizens band (CB) radios and cellular phones, while the motorised wheelchair is turned ON;
- 2) Be aware of nearby transmitters, such as radio or TV stations, and try to avoid coming close to them;
- 3) If unintended movement or brake release occurs, turn the motorised wheelchair OFF as soon as it is safe;
- 4) Be aware that adding accessories or components, or modifying the motorised wheelchair, may make it more susceptible to interference from radio wave sources (Note: There is no easy way to evaluate their effect on the overall immunity of the motorised wheelchair); and
- 5) Report all incidents of unintended movement or brake release to the motorised wheelchair manufacturer, and note whether there is a radio wave source nearby.

Important Information

- 1) 20 volts per meter (V/m) is a generally achievable and useful immunity level against interference from radio wave sources (as of May 1994)(the higher the level, the greater the protection);
- 2) This product has an immunity level of 20 volts per meter (V/m)

GETTING TO KNOW YOUR WHEELCHAIR

4. GETTING TO KNOW YOUR WHEELCHAIR

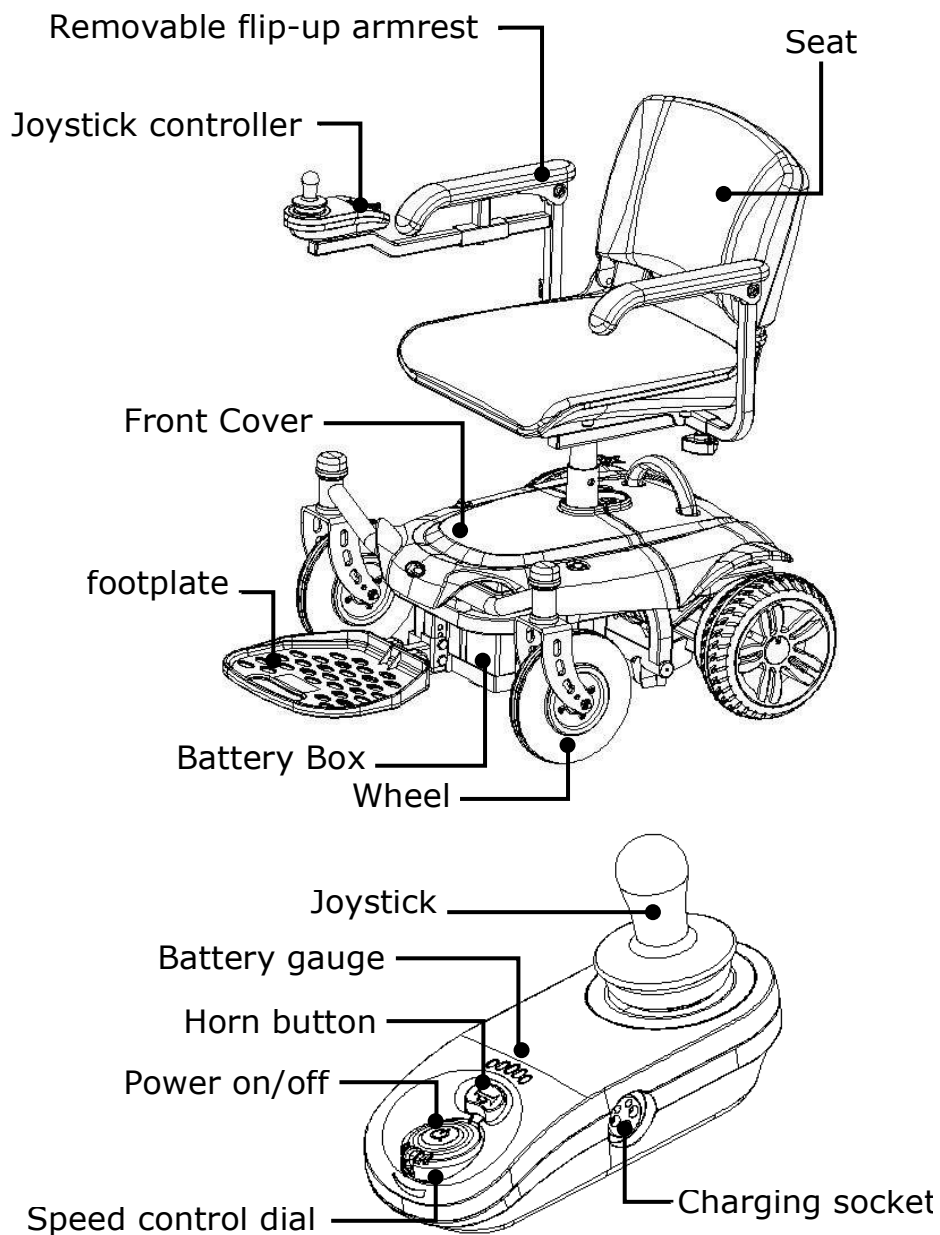

GETTING TO KNOW YOUR WHEELCHAIR

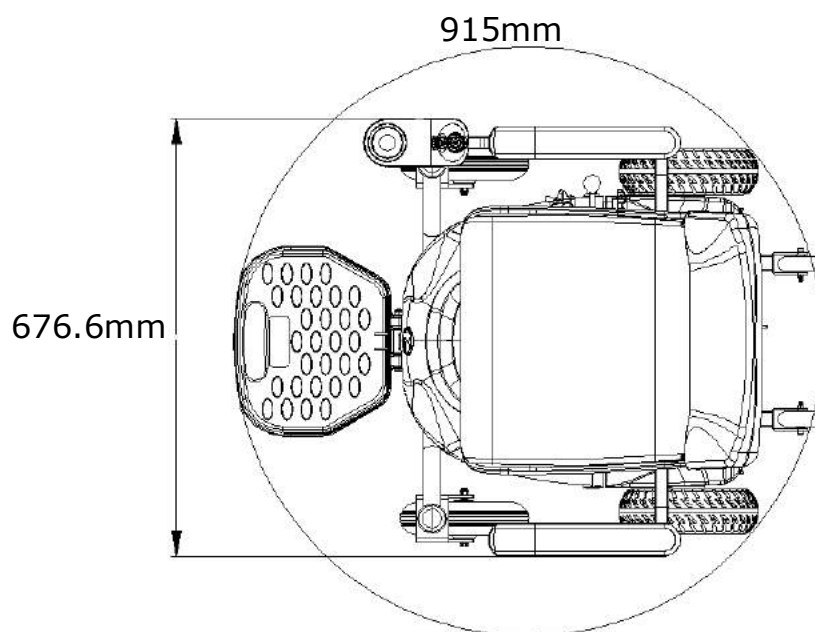
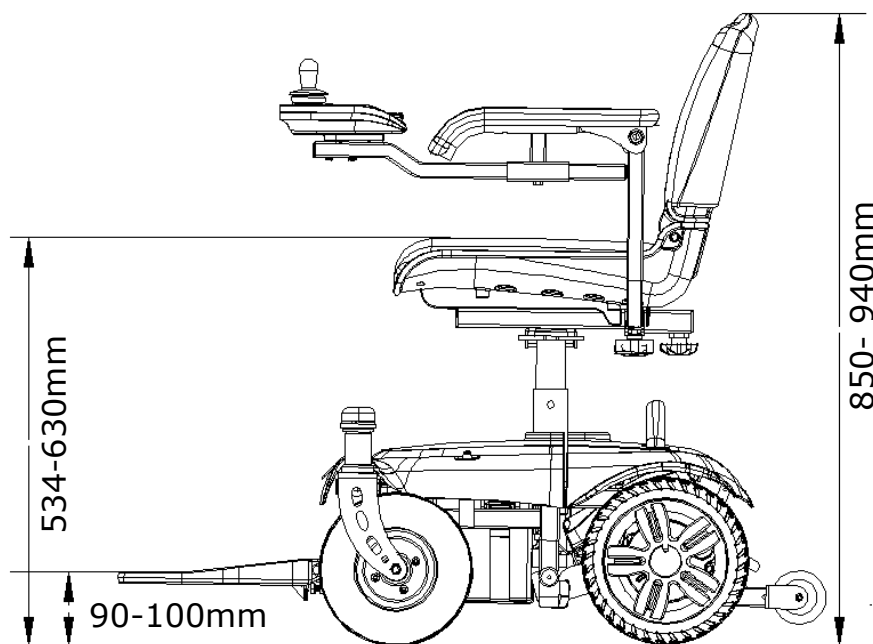

PRODUCT SPECIFICATIONS

5. PRODUCT SPECIFICATIONS

Model Name	EW10BA(UK)
Maximum user weight	18 Stone (114kg)
Overall height	34-37" (864-940 mm)
Overall length (MAX)	35.8" (910 mm)
Overall width (MAX)	24.8" (676 mm)
Drive System	Direct drive rear wheels (with differential gear)
Battery	12 V × 21 Ah × 2 Pcs
Battery charger	Off-board
	Input voltage : 100-240VAC,
	Output voltage : 24VDC Output current : 2A
Front wheel	8" (203mm), PU foam tire
Rear wheel	8.5" (215mm), PU foam tire
Rear wheel drive system	Transaxle
Braking system	Motor electromagnetic brake
Maximum incline angle	6 degree
Per-charge Run distance	Up to 12.5 miles (>20km) *Under full charge case *Maximum weight of 250lbs case
Maximum speed	
Forward	4 mph (6.4 kmh)
Backward	1.25 mph (2 kmh)
Turning radius	18.7" (475 mm)
Height of seat to floor	20"-23.5" (510 - 596 mm)
Overall width of seat	18" (450 mm)
Overall depth of seat	17" (440 mm)
Weight of heaviest part	38 lbs (17.39 kg)

6. PUSHING AND TRANSPORTING THE WHEELCHAIR

1. Please carefully read the safety information in section 3 related to transportation first.

2. Pushing the wheelchair:

In order to push the wheelchair, you must place the wheelchair in "**freewheel**" mode, which disengages the drive motor.

The levers are located at the bottom of the rear section of the wheelchair, attached to the motors.



WARNING!

When the levers are operated in freewheel mode:

- The wheelchair must be on a flat surface.
- Do not sit on the wheelchair.

To push the wheelchair:



=Freewheel Mode: (Motor is disengaged.)

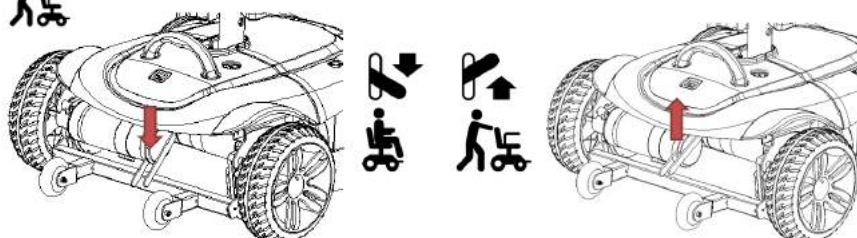

1. Switch the power off.
2. Operate the 2 levers as far as the stop (see diagram).
3. Push the wheelchair to your desired location.
4. Operate the 2 levers as far as the stop (see diagram).



=Driving Mode: (Motor is engaged.)



1. Always switch the wheelchair off to push it.
2. Do not push the wheelchair too fast. If a pre-set speed is exceeded while you are

PUSHING AND TRANSPORTING THE WHEELCHAIR

pushing the wheelchair, the drive motor will switch on an automatic brake to slow the wheelchair.

 After **any** adjustments, repair or service and **before** use, make sure all hardware is tightened securely - otherwise injury or damage may result.

6.1 Parts

You can disassemble the wheelchair into five pieces: the seat, the front section, the Front Cover, the battery pack, and the rear section.

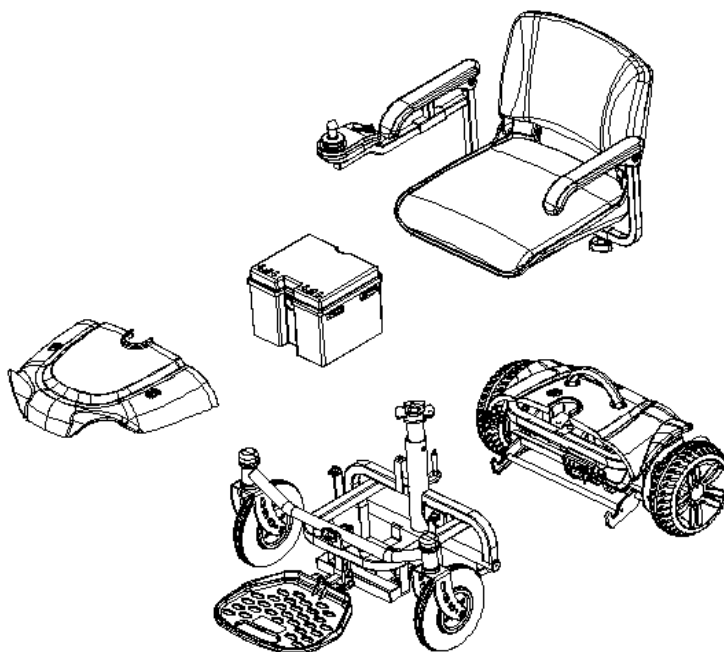

1. Place the wheelchair in an area where you have sufficient clearance to move the parts around. You may need assistance to lift some of the wheelchair components.
2. See "Specifications" for main component weight.
3. No tools are required to disassemble or assemble your wheelchair. Always disassemble or assemble your wheelchair on a level, dry surface with sufficient space

PUSHING AND TRANSPORTING THE WHEELCHAIR

for you to work and move around your wheelchair. Keep in mind that the disassembled sections of the wheelchair take up more floor space than the assembled wheelchair.



Lifting weight beyond your physical capability may result in personal injury.

Ask for assistance when necessary while disassembling or assembling your wheelchair.

6.2 To Disassemble:

1. POWER switch to "OFF".
2. Place the free wheel mode levers in the drive position.
3. Pick up the battery pack and remove it from the wheelchair. (See the pic.)

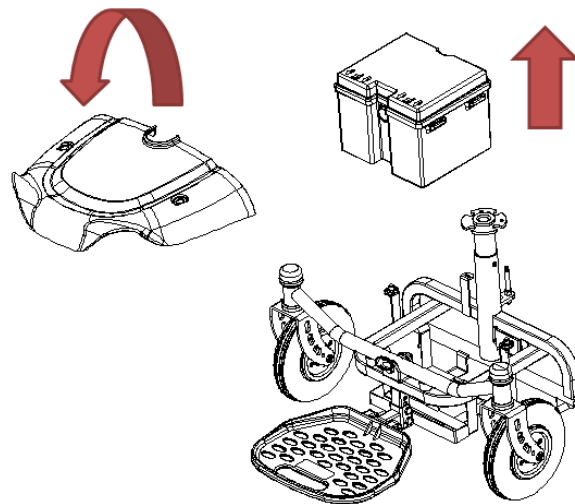

PUSHING AND TRANSPORTING THE WHEELCHAIR

4. Pull the connecting device upward and the front section will be part from the rear section.
(See the pic.)

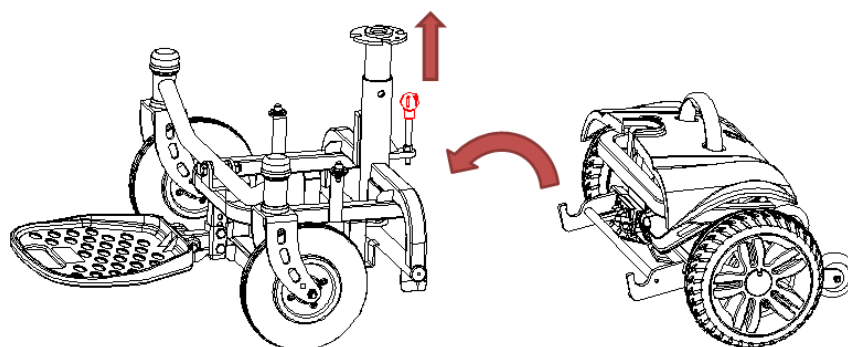

6.3 ASSEMBLY



1. Place the freewheel mode levers into the drive positions.
2. Set the rear section in the up position and pick up the front section to the connecting bracket of rear section. (See pic)

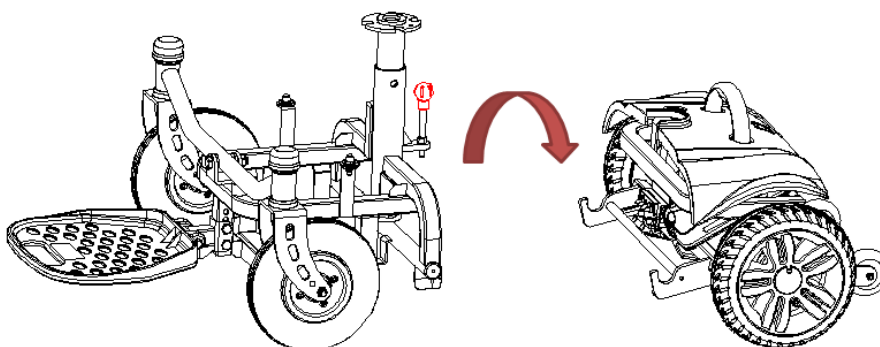

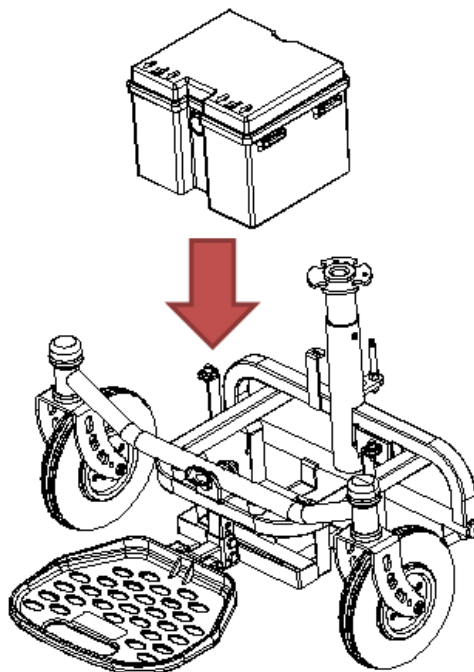

PUSHING AND TRANSPORTING THE WHEELCHAIR

3. Make sure the connecting device is connected securely to the bracket of rear section.
4. Push down the front and rear sections until the wheelchair is level.
5. Set down the battery pack on the wheelchair. (See pic)



6. Pull up the seat lever and set down the seat on the seat post, check that the seat is secure.
7. POWER switch to "ON", make sure battery gauge has sufficient power.

-  Make sure you connect your pieces together properly.
-  Turn off all power to your wheelchair before any items are removed and before disassembly.
-  Ensure the front and rear sections are in the right position before driving.

OPERATING THE WHEELCHAIR

7. ADJUSTING THE wheelchair

The following describes how to set up and adjust your wheelchair in order to have a comfortable and safe drive.

7.1 SWIVELING THE SEAT TO GET ON AND OFF

1. Lift the seat lever and rotate the seat to the side (left or right) to get on.
2. Sit on the seat and turn the seat back to the direction of travel. Lock the seat in place by releasing the seat lever. Fasten your seat belt.

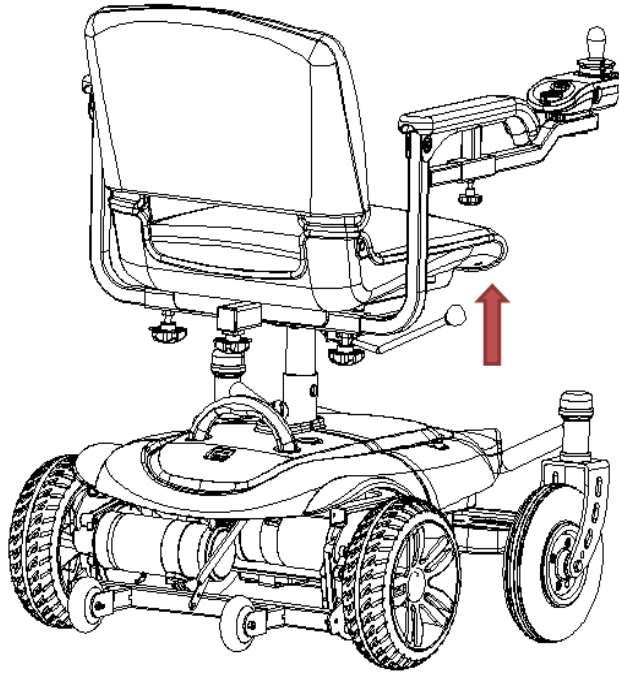

 *Ensure that the seat is properly engaged after adjustment by seeing that the seat doesn't move when you try rotating it to either side*

OPERATING THE WHEELCHAIR

7.2 TURNING THE SEAT

Pull swivel seat lever to rotate the seat.

There are three seats reorientation.

After adjusting the height to the desired seat position, secure the fixing.

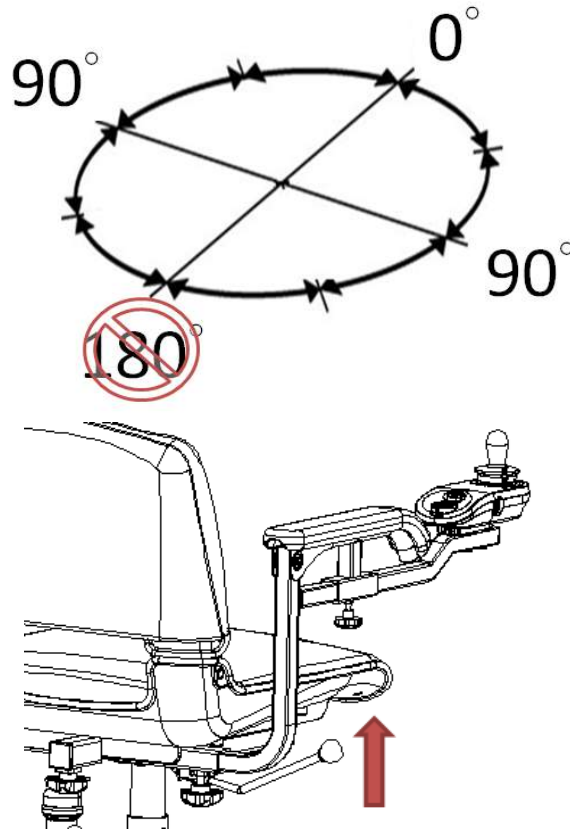

Accident hazard due to incorrect seat position:

Always turn the seat to face forward and lock it before driving.

If the seat has been turned, the possibility of tipping is increased.

Before turning the seat, always ensure that the wheelchair is on an even and solid surface.

OPERATING

8. OPERATING THE wheelchair

Always carry out the safety information described in the "General Safety Information" section:

Before starting to drive, adjust the seat and joystick to a comfortable position.



WARNING! *Every wheelchair is different. Take the time to learn the feel of your wheelchair before you begin riding.*



WARNING! *BE AWARE* that becoming a capable and safe wheelchair operator will take time and practice.



WARNING! *Anti-tippers substantially reduce your risk of tipping over backwards, which can cause serious injury.*

Please observe the following tips for a safe journey:

1. Always match your speed to the driving situation in which you find yourself.
2. Always reduce your speed when you are driving through:
 - Unclear areas
 - narrow gaps
 - Tight curves
 - inclines
 - Ramps
3. Take a trial run with the wheelchair in an area with no pedestrians, or in a closed-off area.
4. Steer the wheelchair carefully and slowly at first.
5. Always keep your feet on the footplate while driving the wheelchair.

OPERATING THE WHEELCHAIR

Check before you power on the wheelchair:

Ensure your wheelchair is in drive mode (not in "freewheel" mode)	Check the "freewheel" mode lever is in the pushed down position
Seat is locked into the desirable position	Move the seat left and right to ensure it is stationary.
Are the batteries charged?	Check the Joystick controller to verify the charging status of the batteries
Are the brakes working?	Check by driving slowly and stopping again
Are the wheels undamaged?	Visually check the condition of the wheels

8.1 POWERING ON/OFF

On the Joystick controller of the wheelchair, there is a power symbol. Power starts after pressing the button, the power is turned on.

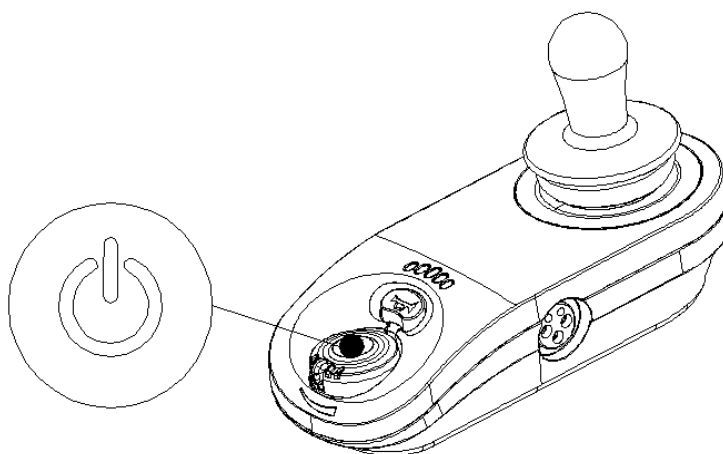

OPERATING THE WHEELCHAIR

8.2 ADJUSTING THE SPEED



Use the speed adjustment mechanisms to adjust the speed to suit your driving conditions. Always use a lower speed if you are uncertain about the driving conditions.

There is one mechanism to control the speed of your wheelchair.

1. Speed Control Dial:

- a. Located to the back of the Joystick controller (see pic) .
- b. It is designed to further adjust your speed from within the high and low preselected speeds.

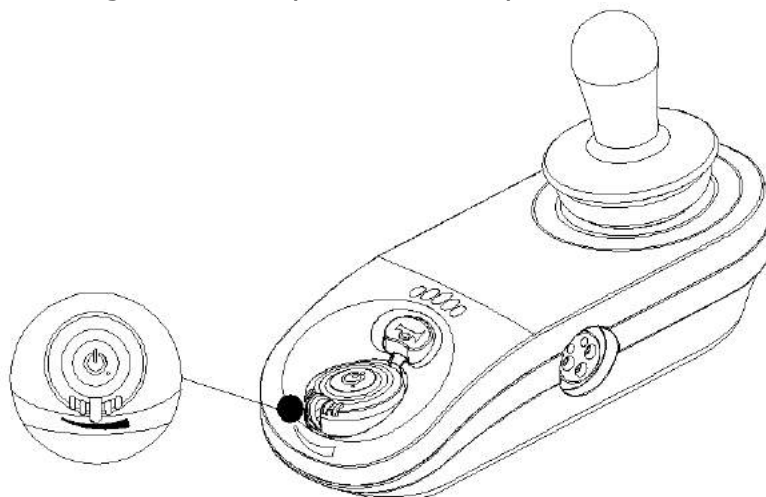

Anticipated Speed levels:

- c. The speed levels are tested under controlled environments and your driving speed may vary depending on the driving conditions and loads.

8.3 Driving directions

Use your thumb, index finger and middle finger on the joystick to control the wheelchair's driving direction.

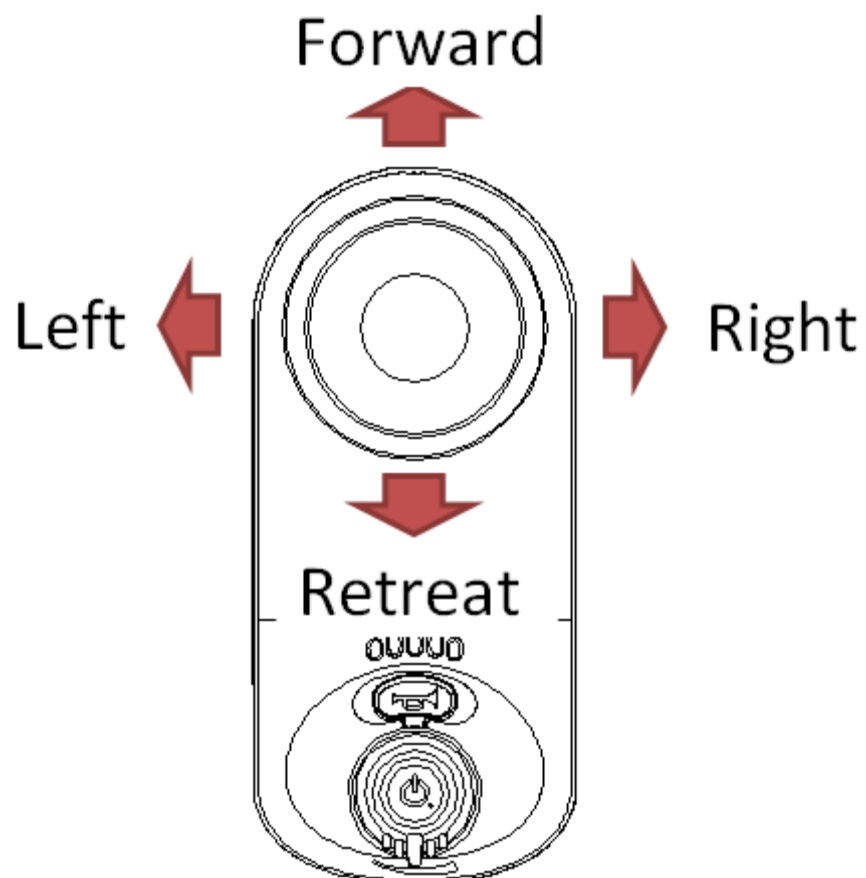

OPERATING THE WHEELCHAIR

8.4 OVERLOAD PROTECTION

The overload protection switch pops out and cuts off the power if the motor(s) becomes overloaded while trying to climb over too high an obstacle, such as a threshold or trying to climb too steep of an incline.

If the motor(s) overload, the following happens:

- The wheelchair stops and the overload trip pops out.

To rectify this:

Locate the overload protection trip (in front of the rear lifting handle to the right) and press it in firmly to reset.

Switch the wheelchair on and reverse away from the



obstacle and then avoid the obstacle.

8.5 SWITCHING ON THE HORN

Press the **horn button**.

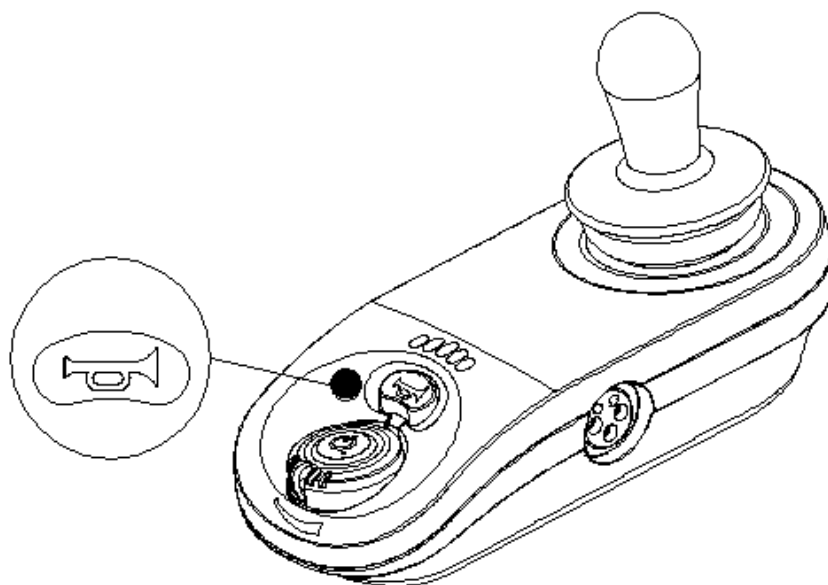

It will sound for as long as you hold the button down.

8. BATTERY AND CHARGING

	Corrosive chemicals contained in battery.
	Explosive conditions exist!
	Warning hands pinching!
	Do not use batteries with different amp-hour (Ah) capacities.
	Keep tools and other metal objects away from battery terminals. Contact with tools can cause electrical shock.
	Flammable material contained in battery. Do not expose to heat sources such as open flame or sparks. Do not transport batteries with flammable or combustible items.
	Disposal and recycling - Contact your approved service provider.

 *New batteries **MUST** be fully charged (approximately 24 hours) prior to initial use of the equipment.*

Always charge new batteries before initial use or battery life will be reduced.

As a general rule, you should recharge your batteries as frequently as possible to assure the longest possible life and to minimize required charging time. Plan to recharge them when you do not anticipate using the equipment.

The range per battery charge, using recommended

batteries, should be approximately 8 to 12 hours of typical operation. Extensive use on inclines may substantially reduce per charge mileage.

9.1 BATTERY STATUS DISPLAY

When the key is switched "ON", the battery gauge will display the battery power capacity by indicating red, yellow and green areas respectively.

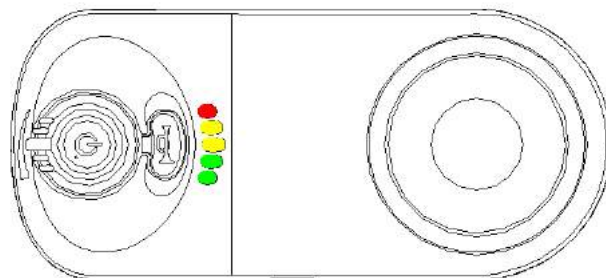

Green area indicates a full charge from the battery.

Red area indicates low power.

The remaining power indicated by the battery gauge will be varied by the actual driving time and how you drive. Repeated starting, stopping or climbing will consume the power more quickly.

If the vehicle is under a heavier load, such as fast acceleration or driving up inclines, the battery status display may move towards the red zone.

This may not indicate the actual status of the batteries.

After a journey, the battery status display may move towards the green zone after the wheelchair has been turned off for a long period of time.

If a battery status display is in the red zone at the end of a journey, the battery must be charged immediately. Otherwise, it can lead to battery damage.

9.2 CHARGING THE BATTERIES

It is imperative that you observe the sequence for connecting and disconnecting the battery charger.

Be sure to follow the procedures shown below.

1. The wheelchair POWER must be switched "OFF".
2. Connect the charger cord to the power outlet.
3. Locate the charging socket on the joystick then connect the charger's plug to the charging socket.
4. The charger's LED light will be orange at the beginning of a charge. The charging duration is at least 8 - 12 hours (but this will vary), based on the status of the battery and temperature.
5. The orange LED will turn to green when the charging is complete.
6. Disconnect the cord and remove the round plug from the charge socket.

**CAUTION**

Do not share the outlet with any other device.

**CAUTION**

To avoid the risk of electric shock, this equipment must only be connected to a grounded supply main.

**CAUTION**

Never use an extension cord to plug in your battery charger.

Step 1. Position the wheelchair near an electric outlet.



Step 2. The wheelchair POWER switch to "OFF".

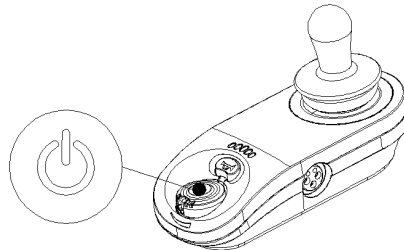

Step 3. Ensure the levers for "freewheel" mode are pushed to the "drive" position.

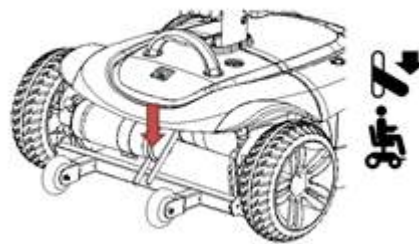

Step 4. Connect the battery charger plug into the charging receptacle located on the joystick controller or the charging socket on the battery box (see below).

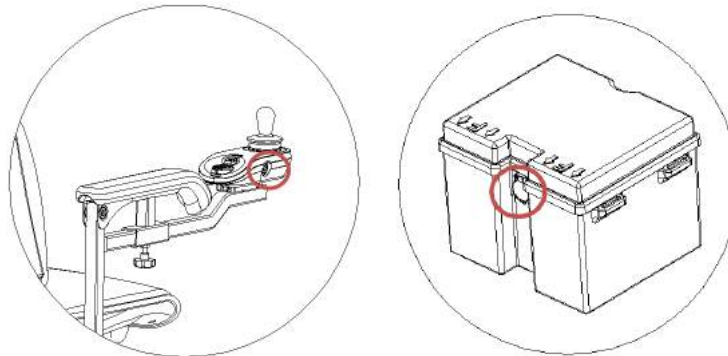

Step 5. Connect the battery charger power plug into an electrical outlet (AC100-240V, 50 to 60 Hz) and charge the battery. (Note: There is no switch on the battery charger).

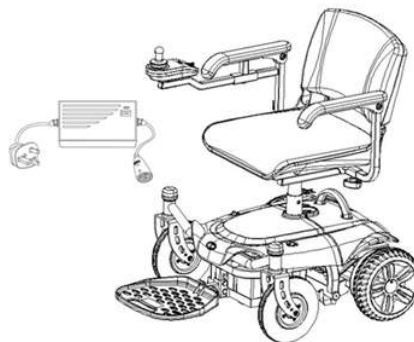

LED information at battery charger during Charging:

LED-> Color-> Meaning

1 --- Red --- charging in progress

2 --- Green --- charging is complete

9.3 AFTER CHARGING

- (1) Switch off and remove the battery charger plug from the household electric socket outlet.
- (2) Remove the battery charger jack plug from the joystick or battery box socket.

9.4 ERROR CODE

When the wheelchair POWER switch is "ON" see if the power on light is flashing and count the sequence.

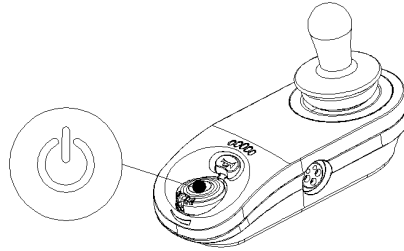

Flash code	Error description	Possible action
1	Remote / joystick error	Check cables and connectors Replace Remote
2	Network or configuration error	Check cables and connectors Check Bluetooth pairing Reconfigure the system Recharge the battery Check charger Replace modules Contact supplier
3	Left motor error	Check cables and connectors Replace Power Module Check and/or replace left motor
4	Right motor error	Check cables and connectors Replace Power Module Check and/or replace right motor

5	Left park brake error	Check cables and connectors Check left park brake is released
6	Right park brake error	Check cables and connectors Check right park brake is released
7	Module error (other than Remote)	Check cables and connectors Check modules Replace LiNX Access Key Replace Power Module Recharge battery

If the wheelchair has stalled, reset the overload trip if it has popped out, cycle the power off then on. Reverse away or remove any obstacles.

The error indicator may continue to flash after an error has been rectified. To clear the error indication, cycle the system's power off and then on.

10.EMI

This portion of the content will provide the user with basic information about the problems with EMI (electromagnetic interference), protective measures can be used to either lessen the possibility of exposure or to minimize the degree of exposure; this section also shows some conditions that unexpected or erratic movements may cause.



CAUTION

It is very important that you read this information regarding the possible effects of electromagnetic interference on your electric KYMCO WHEELCHAIR.

ELECTROMAGNETIC INTERFERENCE (EMI) FROM RADIO WAVE SOURCES

Powered wheelchairs may be susceptible to electromagnetic interference (EMI), which is interfering electromagnetic energy (EM) emitted from sources such as radio stations, TV stations, amateur radio (HAM) transmitters, two-way radios, and cellular phones. The interference (from radio wave sources) can cause the powered wheelchair to release its brakes, move by itself, or move in unintended directions. It can also permanently damage the powered wheelchair's control system. The intensity of the interfering EM energy can be measured in volts per meter (V/m). Each powered wheelchair can resist EMI up to a certain intensity level". The higher the immunity level the greater the protection. At this time, current technology is capable of achieving at least a 20 V/m immunity level, which would provide useful protection from the more common sources of radiated EMI. This powered wheelchair model as shipped, with no further modification, has an immunity level of 20 V/m without any accessories.

There are a number of sources of relatively intense electromagnetic fields in the everyday environment. Some of these sources are obvious and easy to avoid. Others are not apparent and exposure is unavoidable. However, we believe that by following the warning listed below, your risk to EMI will be minimized.

The sources of radiated EMI can be broadly classified into three types:

1. Hand-held portable transceivers (transmitter-receivers with the antenna mounted directly on the transmitting unit). Examples include: citizens band (CB) or hand held radios,(security, fire, and police transceivers), cellular telephones and other personal communication devices.

NOTE: some cellular telephones transmit a signal while they are ON, even though they are not being used.

2. Medium-range mobile transceivers, such as those used in police cars, fire trucks, ambulances and taxis usually have the antenna mounted on the outside of the vehicle.
3. Long-range transmitters and transceivers, such as commercial broadcast transmitters (radio and TV broadcast antenna towers) and amateur (HAM) radios.

NOTE: Other types of hand-held devices, such as cordless phones, laptop computers, AM/FM radios, TV sets, CD player, and cassette players, and small appliances, such as electric shavers and hair dryers, are not likely to cause EMI problems to your powered wheelchair.

POWERED WHEELCHAIR ELECTROMAGNETIC INTERFERENCE (EMI)

EM energy rapidly becomes more intense as one moves closer to a transmitting antenna (source). The **EM fields** from hand-held radio wave sources (transceivers) are of special concern. It is possible to unintentionally bring high levels of **EM energy** very close to the powered wheelchair's control system while using these devices; this can affect your wheelchair's movement and braking. Therefore, the warnings listed below are recommended to prevent possible interference with the control system of a powered wheelchair.



Electromagnetic interference (EMI) from sources such as radio and TV stations, amateur radio (HAM) transmitters, two-way radios, and cellular phones can affect motorized wheelchairs. Following the warnings listed below should reduce the chance of unintended brake release or powered wheelchair movement which could result in serious injuries.

1. Do not operate hand-held transceivers-receivers, such as citizens band (CB) radios, or turn ON personal communication devices, such as cellular phones, while the powered wheelchair is turned ON.
 2. Be aware of nearby transmitters, such as radio or TV stations, and try to avoid getting close to them.
 3. If unintended movement or brake release occurs, turn the powered wheelchair OFF as soon as it is safe.
 4. Be aware that adding accessories or components, or modifying the powered wheelchair, may make it more susceptible to EMI.
 5. Report all incidents of unintended movement or
-

brake release to the wheelchair manufacturer, and note whether there were sources of EMI nearby.

IMPORTANT INFORMATION

20 Volts per meter (V/m) is generally a useful immunity level against EMI (the higher the level, the greater the protection).
This product has an immunity level of 20 V/m without any accessories connected to it.

Date printed: May.2016
