

oxford

Together we
transform lives

User Instruction Manual

Oxford® Canvas Stretcher

To avoid injury, read user manual prior to use. For alternative languages, contact your authorised service provider. Always refer to www.oxfordhealthcare.co.uk for latest revision.

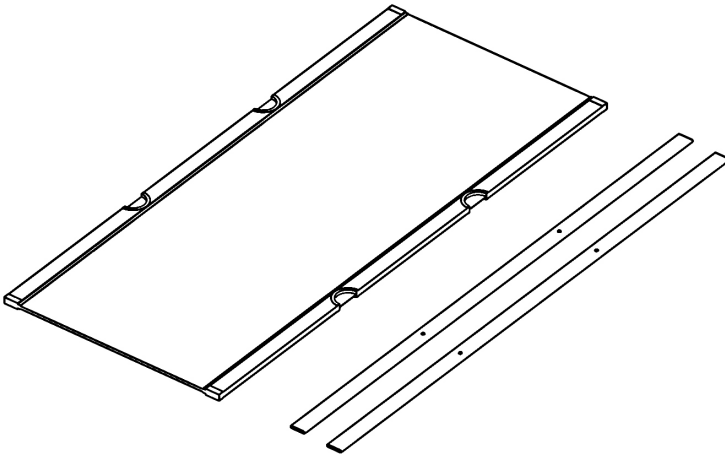

Contents

1. Oxford Canvas Stretcher.....	3
2. Safety Precautions	4
3. Assembly & Commissioning Instructions	5
4. Lifting With Your Oxford Canvas Stretcher	6
5. Cleaning & Maintenance	10
6. Warranty	11

Symbols



This product is a Medical Device in accordance with EU Medical Device Regulation 2017/745.



Machine wash at 85°C



Do not bleach



Do not dry clean



Drip dry



Area/side for feet/legs



Area/side for head



ATTENTION, consult accompanying documents.



Refer to the user instructions before use (Blue background).



Certification mark indicating conformity with the applicable requirements for products sold within Great Britain.



A point of contact between the non-European medical device manufacturer, the national Competent Authorities (Ministry of Health) and Notified Bodies.



A unique device identification intended to provide single, globally harmonised positive identification of medical devices through distribution and use.



Indicates the entity importing the medical device into the locale.

1. Oxford Canvas Stretcher

As an aftermarket accessory, you can retro-fit your Stature or Presence lift with an Oxford Canvas Stretcher (see Fig.1). This **MUST ONLY** be used in conjunction with the Oxford Stretcher Adjustment Cradle (Part Number OXF-STRETCHER-AC).

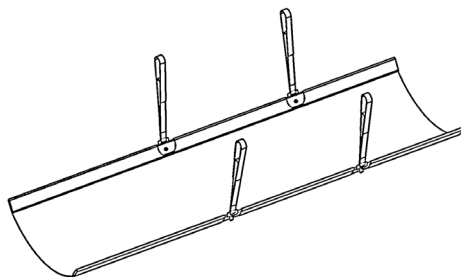

Fig. 1

Item Number: SL30010

Safe Working Load: 227Kg (500lbs).

(When fitted to the Oxford Stretcher Adjustment Cradle - Item Number OXF-STRETCHER-AC).

Intended Use:

The Oxford Canvas Stretcher is a patient handling device which must be used in combination with the Oxford Stretcher Adjustment Cradle (OXF-STRETCHER-AC) and either an Oxford Stature or Presence lift.

The Canvas Stretcher is intended for lifting and transferring patients in a horizontal position where a flat underlying surface is not particularly required and when a patient needs to be moved with very little change in body position.

The Canvas Stretcher is for use by a minimum of two trained operators.

Advantages of the Canvas Stretcher include:

- It takes up relatively little space during use and when in storage.
- It can be laundered in a washing machine at 85°C.*

* Metal rod inserts to be removed and cleaned separately. (See section 5 of this manual).

Serious Incident Reporting:

In the event of a serious incident taking place during use of this product, affecting the patient and/or care-giver, it must be reported to the product manufacturer or authorised distributor. Should the incident take place within the European Union (EU), it must also be reported to the local competent authority within the member state.

2. Safety Precautions

⚠ WARNING

The Oxford Canvas Stretcher **MUST ONLY** be used with an Oxford Stretcher Adjustment Cradle (Part Number OXF-STRETCHER-AC)

When the Canvas Stretcher is attached, the patients head and body should always remain horizontal. This horizontal position is achieved by operating the adjustment handles on the Stretcher Adjustment Cradle in either a clockwise or anti-clockwise direction. (see Fig.2)

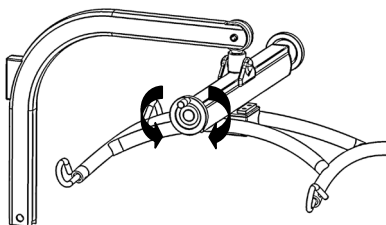

Fig. 2

⚠ WARNING

Ensure the patient is positioned in the correct orientation prior to connecting the Canvas Stretcher to the Stretcher Adjustment Cradle (see Fig.3).

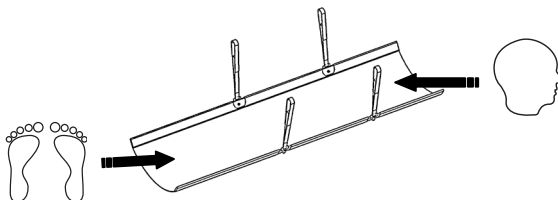

Fig. 3

⚠ WARNING

Do not attempt to lift the patient if the patient's weight is off centre balance (see Fig.4).

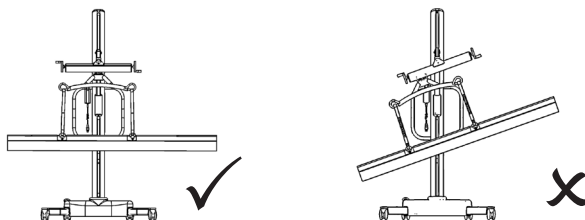

Fig. 4

⚠ WARNING

- The Oxford Canvas Stretcher is **ONLY** compatible with the Oxford Stature and Presence lifts when fitted with the Oxford Stretcher Adjustment Cradle Part Number OXF-STRETCHER-AC).

- **Never use a Canvas Stretcher if the suspension straps are cut or frayed or the stitching is damaged.**
- **Always plan your lifting operations before commencing the lift.**
- **Always check the Canvas Stretcher is in good working order prior to all lifting operations.**

3. Assembly & Commissioning Instructions

The following components are included with your Canvas Stretcher (see Fig.5).

- 1 x Canvas Stretcher (1)
- 4 x Suspension Straps (2)
- 2 x Splints (3)
- 1 x Pack of 4 Connection Points (not shown)

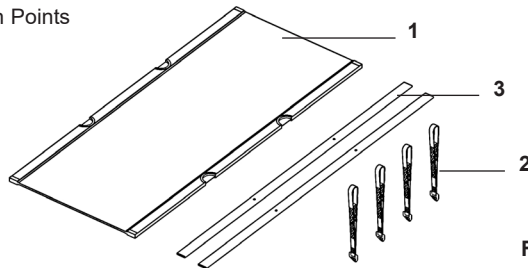

Fig. 5

Initial Assembly

Prior to using the Oxford Canvas Stretcher, an initial assembly of the connection points will be required.

FOLLOW THESE INSTRUCTIONS EXACTLY:

1. Place the nylon washer onto the shoulder of the connection bolt (see Fig. 6).
2. Place the connection bolt through the hole in the splint (see Fig. 7).
3. Fix the connection bolt in place with a button head screw and steel washer (tighten to 14Nm) (see Fig. 8).

Required Tools: 1 x 13mm Spanner/Socket, 1 x 5mm Allen Key, 1 x Torque Wrench

4. Repeat steps 1 - 3 for the remaining three connection points.

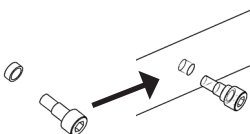

Fig. 6

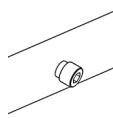

Fig. 7

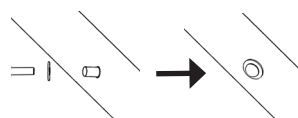

Fig. 8

4. Lifting With Your Oxford Canvas Stretcher

FOLLOW THESE INSTRUCTIONS EXACTLY:

1. Place the folded Canvas Stretcher on the bed or a suitable supporting surface (see Fig. 6).

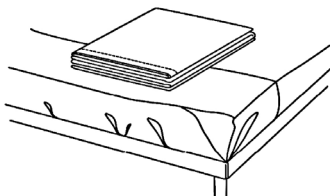

Fig. 6

2. Unfold the Canvas Stretcher, ensuring that the stretcher is correctly orientated. This will be confirmed when the openings on either side are as shown (see Fig. 7) and the head and feet labels are visible.

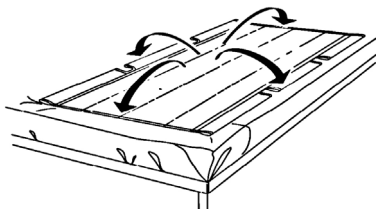

Fig. 7

3. Position the Canvas Stretcher adjacent to the patient, ensuring the supporting surface is suitable (see Fig. 8).

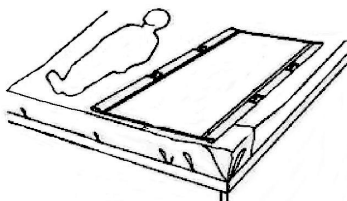

Fig. 8

4. Position the patient centrally on the Canvas Stretcher, so that they are lying on their back (see Fig. 9). Always ensure you follow your health and safety procedure for manual handling/positioning.



Fig. 9

⚠ WARNING

Ensure the patient is positioned in the correct orientation prior to insertion of the splints

Note: The head & feet symbols indicate the correct patient positioning (See Fig. 10).

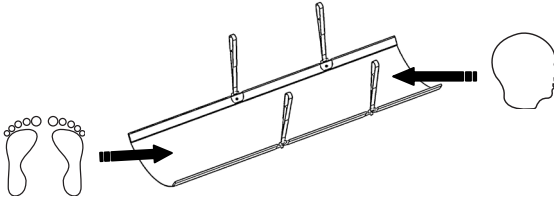

Fig. 10

5. Insert the two splints into the side pockets - one either side of the Canvas Stretcher, ensuring the splints are orientated correctly. This will be confirmed when the two suspension spigots on each splint protrude through the two openings on either side of the Canvas Stretcher. Ensure the suspension spigots face outwards. (see Fig. 11).

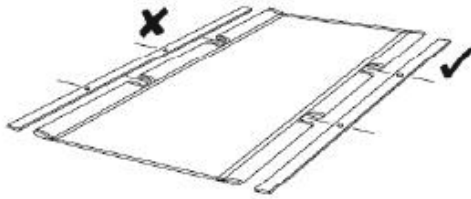

Fig. 11

⚠ WARNING

The splints can only be inserted at one end (see Fig. 12).

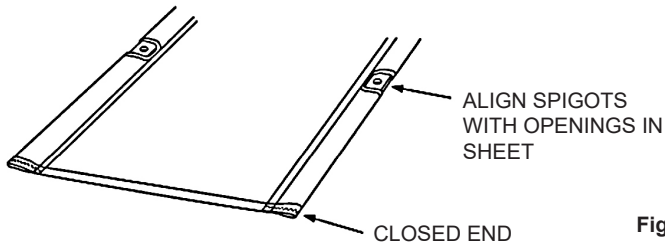

Fig. 12

6. Attach each of the four suspension straps to the suspension spigots on the splints as illustrated. (see Fig. 13).

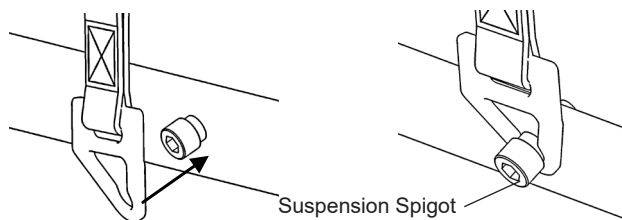

Fig. 13

⚠ WARNING

Ensure all of the four attachment brackets are orientated in the correct location (See Fig.13) and that they are securely attached. This will be confirmed when the attachment bracket 'snaps' onto the suspension spigot attached to the Splints.

⚠ WARNING

Ensure all four Suspension Straps are not showing any signs of fraying or damage. If there is any evidence of fraying or damage on ANY of the four Suspension Straps, DO NOT USE. The Canvas Stretcher must not be used until genuine replacements are obtained.

⚠ WARNING

Check the condition and ensure secure attachment of spigot on the splint prior to lifting.

7. Carefully position the Stature/Presence hoist, with the Oxford Stretcher Adjustment Cradle fitted, above the patient. (see Fig. 14).

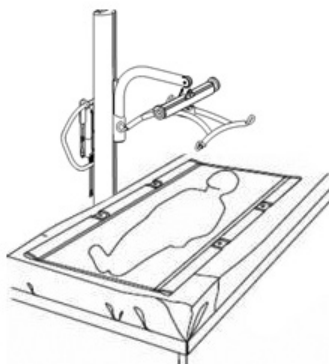

Fig. 14

8. Carefully lower the boom of the hoist so that the Stretcher Adjustment Cradle is directly above the patient in a position that the Canvas Stretcher suspension straps can be easily attached to the Stretcher Adjustment Cradle. (see Fig. 15).

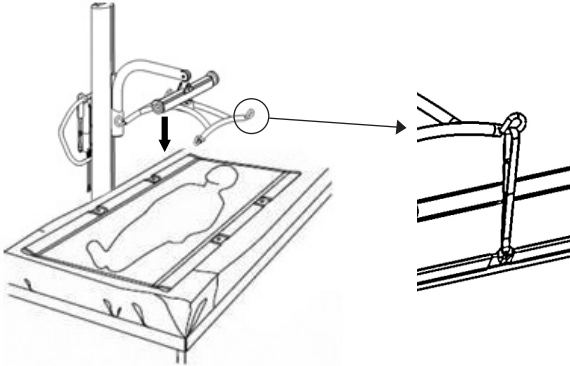

Fig. 15

9. Attach the four Canvas Stretcher suspension straps to the Stretcher Adjustment Cradle (see Fig. 16). Either the longer or the shorter loops can be used, which ever are most appropriate for each individual patient, (see Fig. 17) but DO NOT mix both sizes.

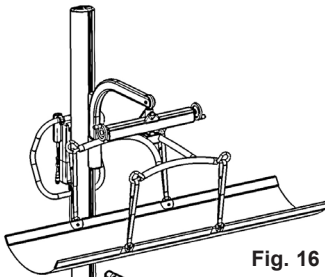

Fig. 16

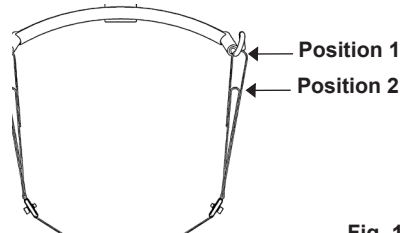

Fig. 17

⚠ WARNING

Ensure all four Suspension Straps are securely attached to the Stretcher Adjustment Cradle. Failure to do so may result in serious injury.

10. Raise the patient approximately 150mm (6 inches) above the bed or supporting surface. Verify that the patient and Canvas Stretcher are horizontal and stable before transporting the patient.

⚠ WARNING

Do not attempt to lift the patient if the patient's weight is off balance (see Fig. 4, page 4)

11. **NOTE:** Adjustment can be made by operating either the left or right hand handles on the Stretcher Support Cradle by rotating either clockwise or anti-clockwise to level the patient for additional comfort and stability. (see Fig.18).

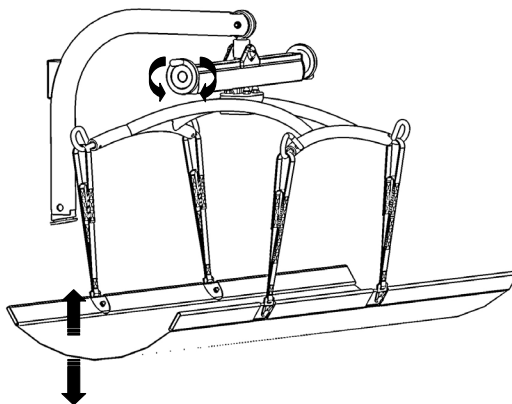

Fig. 18

12. Once the patient is supported with the stretcher balanced centrally, the patient can be transferred.

5. Cleaning & Maintenance

Ensure the following guidelines are adhered to when cleaning your Oxford Canvas Stretcher.

Canvas & Straps:

- Do not wash with bleach.
- Do not twist.
- Do not wash and dry by machine.
- Wash with a neutral cleaner. Rinse using clean water.
- Air dry or dry at a very low temperature.

Metal Rod Inserts:

- Wash with a neutral cleaner. Rinse using clean water.
- Air dry or dry at a very low temperature.

Operation/Storage Conditions:

Operating temperature 5°C to 40°C
Storage temperature..... 5°C to 40°C
Relative humidity 10% to 95%

Daily Maintenance Checklist:

1. Check the canvas and all seams (including stitching) on the Canvas Stretcher for fraying, tears or any other damage.

WARNING

DO NOT use the Canvas Stretcher if there are any signs of wear or damage. Serious injury to the patient and/or carer can occur.

2. Check all suspension straps for signs of wear or damage. DO NOT use the straps if there are signs of fraying edges, tears or damage to the strap or stitching.
3. Check all four connection points on the aluminium splints. Ensure they are securely fastened and not loose and there are no signs of damage.
4. Refer to the Stretcher Adjustment Cradle user manual for additional safety information.

End of Life Disposal

Slings: Slings and associated material accessories should be sorted as combustible waste in accordance with local or national regulations.

6. Warranty

Oxford has an established network of reputable distributors and dealers who will be pleased to handle all your purchasing, warranty, repair and maintenance enquires.

This product is guaranteed for a period of twelve months from the date of manufacture or twelve months from the date of purchase if commissioned by an authorised dealer. We recommend that all of our products are commissioned by your dealer and are supported by them for future servicing.

The dealer or distributor operates the warranty programme, so it is important to keep a record of their name address and telephone number so they can be contacted should any problem arise.

If you are in doubt as to where your product was purchased, Oxford can trace the supplier if you quote the serial number of the lift. Contact details can be found on the rear cover of this manual.

REMEMBER: Contact your distributor for purchases, warranty, repairs, servicing and certified maintenance.

Your distributor:

oxford

 Oxford Medical Healthcare Ltd
Drakes Broughton Business Park, Worcester Road, Drakes Broughton
Persore, Worcestershire, WR10 2AG United Kingdom
(T) 0344 811 1158 • (W) www.oxfordhealthcare.co.uk • (E) info@oxfordhealthcare.co.uk