

molift[®]

MOVER 300



CE

Rev E 24/09/2013

molift[®]
a part of Etac

BM06101 Molift MOVER 300 English

OPERATOR MANUAL

Table of content

About Molift Mover 300.....	3	Equipment.....	14
<i>Before using the patient lifter</i>	3	<i>Quick release suspensions</i>	14
<i>Explanation of symbols</i>	3	<i>Castor with directional lock</i>	14
General safety precautions.....	4	<i>Integrated charger.....</i>	14
<i>General</i>	4	<i>Suspension with scale.....</i>	14
<i>Lift and transfer</i>	4	<i>Molift Stretcher</i>	14
Assembly and disassembly.....	5	Troubleshooting	15
<i>Unpacking</i>	5	Maintenance	16
<i>Assembly.....</i>	5	<i>Cleaning.....</i>	16
<i>Disassembly.....</i>	6	<i>Monthly inspection</i>	16
<i>Storage.....</i>	6	<i>Periodic inspection</i>	16
Checklist before use	7	<i>Service</i>	17
Molift Mover 300 - use.....	7	<i>Checklist for periodic inspection.....</i>	18
Lift and transfer	8	<i>CE Declaration</i>	19
<i>Use of spread legs</i>	8		
<i>Using lifting slings</i>	8		
Safety devices	9		
<i>Emergency stop and lowering.....</i>	9		
Battery and charger system.....	10		
<i>Battery care and charging</i>	10		
<i>Battery capacity.....</i>	10		
<i>Electronics.....</i>	10		
Technical data	11		
<i>Labelling.....</i>	12		
Accessories	12		
<i>Lifting sling</i>	12		

About Molift Mover 300

Molift Mover 300 is a mobile lifter intended for lifting and transferring persons to/from bed, floor, chair or similar, wheelchair and toilet. The lifter is made out of light-weight materials, has castors and is powered by a battery. It has electrically adjustable legs and a lifting capacity of as much as 300 kg (660 lbs). It is therefore ideal for institutional care settings but can also be used in private homes and nursing homes. The lifter should only be used for transfers across short distances, such as between a chair and a bed or into bathroom/rest room and cannot replace a wheelchair or similar.

The Molift Mover 300 with accessories as described in this manual are CE marked according to the Council Directive concerning medical devices (93/42/EEC). The lifter is classified as medical equipment class 1, and tested and verified by a third party, according to standards IEC 60601-1, IEC 60601-1-2 and NS-EN ISO 10535:2006.

Before using the patient lifter

See page 5 for mounting description.

Before using a patient lifter, the operator should be trained accordingly. Practice lifting a colleague, and be lifted by others. It is important not only to know how to move another person using the lifter, but also how it is to be lifted. Try and practice using the relevant slings for the different types of lifts and movement you may encounter. Before lifting a person, you should explain the procedure.

When using the lifter, it's also important to use the correct sling and accessories according to:

- type of disability
- size
- weight
- type of movement



If a fault associated with the operational safety and reliability is identified, the lifter must be taken out of use immediately and marked "Out of order" or not put into use at all.

Explanation of symbols



This symbol is used to point out instructions and information related to workplace safety where injury may occur if the information is disregarded or ignored. Follow these instructions, be careful and attentive at all times.



This symbol indicates important and useful information. If taken into consideration, it will help the operator of the lifter to work efficiently. It may help simplify routines and to explain complicated facts.



General safety precautions

General

Before putting a Molift Mover 300 into operation, the operator must ensure that the lifter and accessories are in good working order, especially with regards to safety.

A Molift Mover 300 shall only be used when all safety devices and equipment is in place and fully operational.

The lifter must be taken out of service immediately, or not returned to service, if faults and/or irregularities that may have influence on the safety are discovered.

 The lifter has an expected lifetime of 10 years or 30 000 lifts with max load (SWL), when all recommended service is performed.

Injury to personnel or equipment may occur if Molift Mover 300 is used in an incorrect manner and if i.e.:

- covers are removed by unauthorised personnel
- used incorrectly
- insufficient maintenance
- load exceeds maximum limit. The maximum load stated in this manual and on the lifter is the maximum load.
- unauthorised repair of electrical devices or cables.

Lift and transfer

 *The Molift Mover 300 has a Safe Working Load of 300 kg/660 lbs, meaning that it is tested and approved for lifting of patients up to 300 kg/660 lbs. Attempts to lift patients above SWL may damage the lifter and lead to personal injury.*

 *The patient lifter may tip over if used incorrectly! Ignorance of warnings and instructions may lead to personnel injury. Read instructions carefully before attempting to lift anyone.*

 *Pay close attention to your actions. Ensure that all four loops of the sling are securely fastened to avoid the user slipping or falling.*

 *Use the push handle to manoeuvre the lift, do not attempt to manoeuvre the lift by pushing on the lifting arm, actuator or arm.*

 *Torn, cut, frayed or broken slings can fail, resulting in serious injury to the user. Use slings in good condition only. Destroy and discard old, unusable slings.*

 *Molift slings shall only be used to lift persons. Never use sling to lift and/or move objects of any kind.*

 Molift Mover 300 should not be run constantly for more than 2 minutes (with maximum load), and rest for minimum 18 minutes.

 If the lifting movement does not start when the corresponding button is pressed, please consult the fault finding table in the maintenance chapter to locate the fault.

Several factors have to be considered during movement of the lifter. Stand to the side of the lifter when lifting. Ensure that arms and legs are clear of the lift, chair, bed etc. try to maintain eye contact with the user - this will help the user feel safe and comfortable.

 Medical electrical equipment requires special precautions regarding electromagnetic compatibility (EMC). Portable or mobile radio communication equipment may affect the medical electrical equipment, and should be kept minimum 25 cm (10 inches) from the lifters electronics

Assembly and disassembly

Unpacking

- The lifter comes in one cardboard box. Verify that the box has no apparent damage. If damaged, check the content and contact your dealer for assistance if components are damaged.
- The box contains one complete Molift Mover 300 lifter with hand control, battery and battery charger with mains cable.

Assembly

- The chassis should be rolled out of the box.
 - Charge the battery, see page 10.
- Note! The battery must not be in the battery holder during assembly!
- Place the column in the attachment on the chassis, and push the column down as shown below. The screw in front of the column should fit in the slot inside the chassis.
 - Make sure that the red arrow on the lower part of the column corresponds with the lock handle. Fix the column with the lock handle. If the column is not placed correct the lifter will not work.

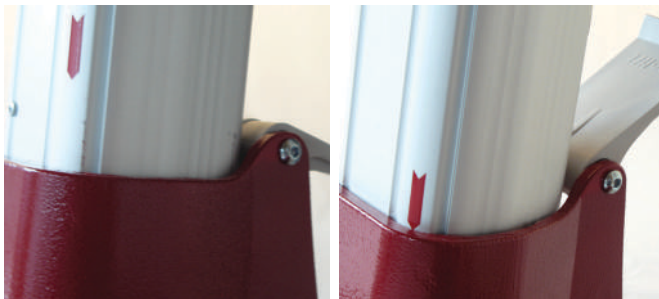

- Fix the column by pushing the lock handle on the back all the way down



- Connect the hand control cable to the contact on the underside of the battery holder. The hand control has a hook that makes it possible to hang it on the drive handle or the plastic hooks on the column.

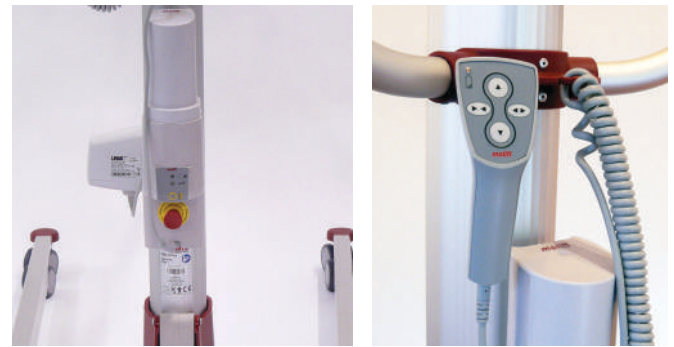

- Place the battery in the holder with the connectors facing down. Release the emergency stop and run each function of the lifter to verify proper function. (Always charge batteries before the lifter is ut into service).
- Mount the suspension by turning the opening in the end cover upwards, and slide the attachment fork in place (as shown below).

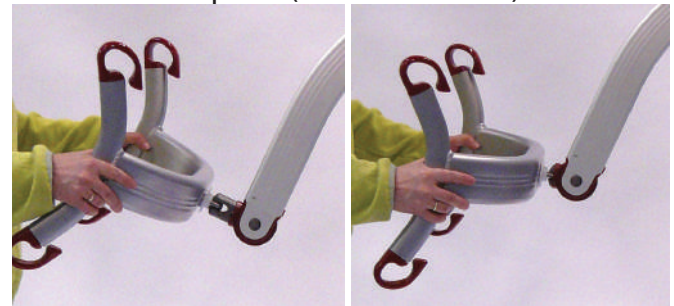

Check that the lifter is mounted correctly with no loose parts or damages. Ensure that the suspension and lifting column are properly fixed.

Checklist after mounting

- Check the lifter according to checklist before use on page 7.

Disassembly

- Remove the suspension.

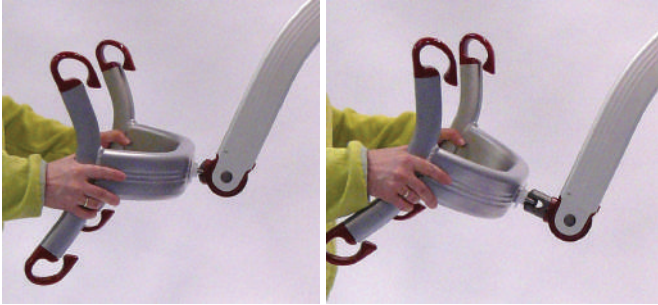

- Run the lifting arm all the way down.
- Remove the battery to avoid it from falling out during transport.
- Release the lock handle on the chassis end remove the complete column with lifting arm.



- Place the hand control on the drive handle.

Storage

For long time storage it is recommended that the battery is removed and the emergency stop button is activated. The lifter can be stored and transported under the following conditions:



Pressure: 70 - 106 kPa

Humidity: 15 - 93 %

Temperature: -25 - 70 °C

The lifter is designed for use at standard room temperatures (+5 to +40°C). Following storage or transport at other temperatures leave the lifter in a room with a suitable temperature until it reaches a safe operating temperature.

Checklist before use

1. Check that the lifter has no apparent damage or other faults.
2. Ensure that the lifting arm and lifting column are properly fixed and that there are no loose parts on the lifter.
3. Check that the emergency button is deactivated and that the lifter works.
4. Check that you have sufficiently charged batteries to complete the task you have planned (no lights on the battery lamps).
5. Check that the service lamp gives a green light indicating it is ready for use. If the service lamp gives a yellow or red light, the lifter needs service.
6. If faults or irregularities are discovered, the lifter should be taken out of service. Contact your service partner or local Molift representative.

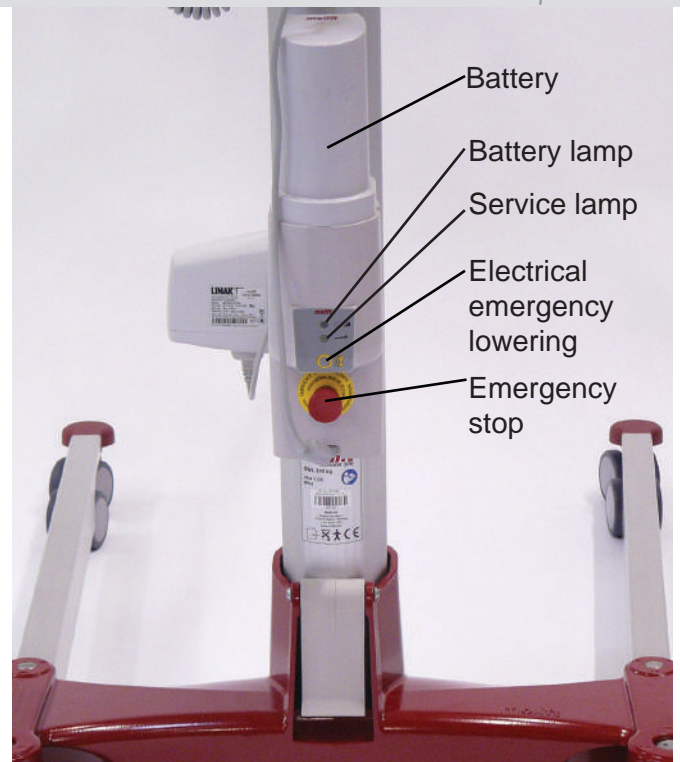

Molift Mover 300 - use

The Molift Mover 300 hand control has four buttons, two buttons for up and down, and two buttons for adjusting the adjustable legs in and out. In addition there is a LED battery lamp which illuminates when the battery needs charging.

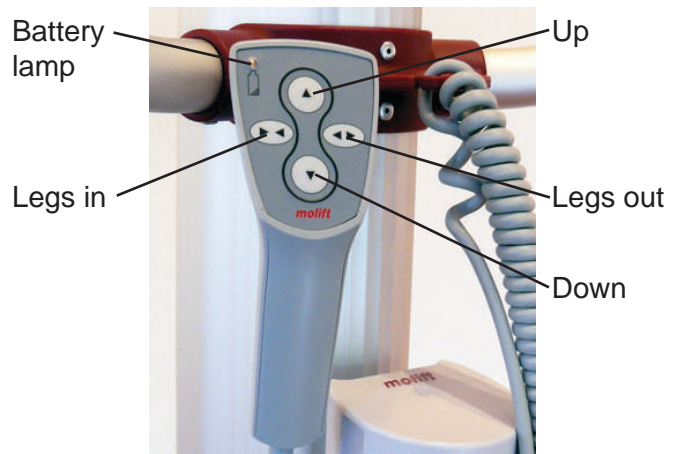

Lift and transfer

The suspension shall always be positioned across the user as shown left in the illustration below.

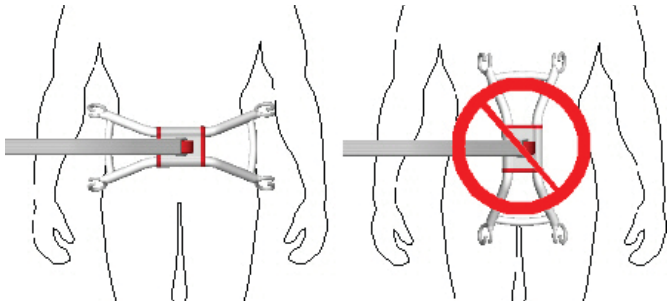

 Check that the sling is properly fastened to all four hooks on the suspension to make sure the patient is not sliding or falling out.

Try to position the user as low as possible (preferably resting the feet on the chassis) when transferring the lifter with a suspended user. In this way, the centre of gravity will be as low as possible and therefore reducing the risk of instability. The lifter should be manoeuvred with spread legs in outer position to achieve the highest possible stability.

Be careful during movement - the suspended user may swing somewhat during turns, stops and starts. Be particularly careful when manoeuvring close to furniture to prevent the suspended user from colliding with these objects.

 The lifter shall not be used to lift or move users on sloping surfaces.

Avoid deep pile carpets, high thresholds, uneven surfaces or other obstacles that may block the castors. The lifter may become unstable if forced over such obstacles increasing the risk of tipping over.

 The lifter shall only be used for movement over short distances. It is not a replacement for wheelchair or similar.

Use of spread legs

Use wide legs wherever appropriate, for instance to position the lifter around wheelchairs, toilets etc. The leg spreading mechanism has a safety function preventing it from squeezing with high force. This may lead the motor to stop if changing direction quickly. Push another button to start again.

Using lifting slings

The Molift lifting slings are easy to use. Please see the user manual that comes with the sling for specific instructions.

 It is recommended to use Molift Easy slings. Slings from other manufacturers may have other specifications leading to unexpected instability and possible injury to personnel.

 Torn, cut, frayed or broken slings can fail, resulting in serious injury to the user. Use slings in good condition only. Destroy and discard old, unusable slings.

Molift Easy sling



Fold the sling as indicated above before use. The grey side should be facing away from the user when putting the sling in place. The sling should be held by one hand, leaving the other free to move and support the user.

Safety devices

Molift Mover 300 is equipped with several safety devices, which are intended to prevent damage to personnel and equipment in the case of incorrect use.

- The lifter has an overload sensor preventing the lifter to be operated with more than safe working load, 300 kg/660 lbs. If the load exceeds the SWL, the lifter will stop the movement.
- The lifting arm is hinged to prevent the arm and suspension from squeezing the patient if it is lowered too much. The actuator will not produce any force when moving downwards.
- The suspension has safety hooks to prevent the sling loops to fall off.
- The electronics are disabled if the temperature rises beyond a critical limit. Wait until the lifter has cooled down before using it again.

Emergency stop and lowering



Contact your Molift service partner if the reason for failure causing an emergency lowering is unknown or if it is a result of failed components or parts.

Emergency stop

The emergency stop will cut the power to the actuator, and is situated on the battery holder on the lifting column. Turning it clockwise until it pops out will reset the emergency button.

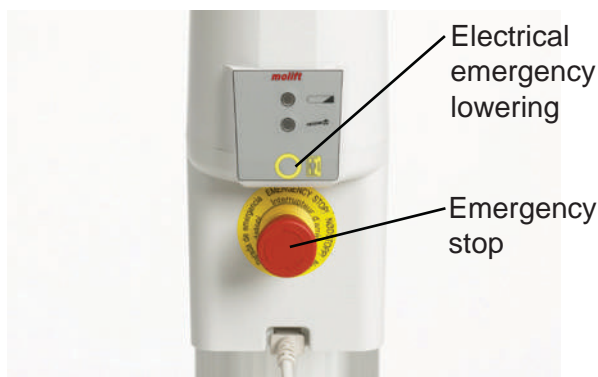

Electrical emergency lowering

It is possible to perform an emergency lowering of the lifting arm in case of a general malfunction of the control electronics. The button can be found on the battery holder. If you need to perform an emergency lowering, move the lifter to a suitable location to lower the user.

- Press the emergency lowering button. The lifting arm will then perform a smooth downward movement. The emergency stop button can not be activated when performing electrical emergency lowering.
- If the lifter still does not work, change battery and try the emergency lowering procedure again.
- If it still does not work, the suspended user must be lifted out manually either by using the manual lowering function or by requesting assistance.

Manually emergency lowering

The manually lowering function on the actuator is only to be used when the electrical lowering does not work.

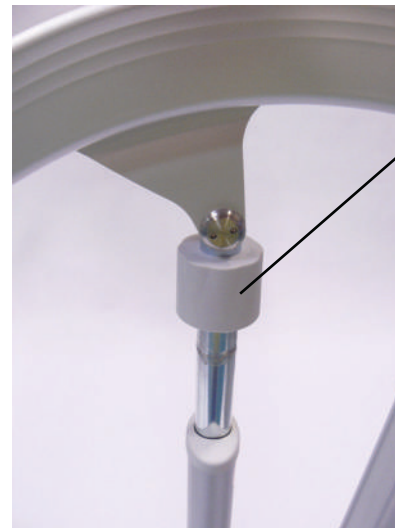

Manual emergency lowering

Turn clockwise (see arrow on top) to lower the lifting arm carefully until the patient is safely placed in a bed or a chair.

Battery and charger system

Battery care and charging

Molift Mover 300 is supplied with a battery with a 26,4 V cell unit that is placed in the battery holder on the lift. A battery charger is also supplied to be located easily accessible, either stand-alone or mounted on the wall. Connect the charger mains cable to the wall socket when charging the battery. The Charger must be placed or installed in a way that makes it easy to disconnect mains cable plug. Disconnect the charger mains cable plug when the charger is not in use. Take care not to damage the cable



Place the battery in the charger. After a few seconds the LED will change from yellow to orange, indicating that the battery is charging. When the LED gives a constant green light the battery is fully charged. The charger LED (Light Emitting Diode) is indicating the status of the battery as described below:

Charger LED	Mode
Yellow	No battery
Yellow	Initiation (10 sec)
Red	Fast charge
Green/Yellow	Top-off charge
Green	Trickle charge
Red/Green	Error

Battery capacity

The battery lamp on the hand control and on the battery holder will illuminate if the voltage of the battery falls below a certain level, indicating the need for charging. There will also be an audible signal. There is still enough capacity to perform

3-5 lift cycles (75 kg/ 165 lbs) at this point.

- i** If the battery is discharged during a lift, it is always enough power to lower the user down again.
- i** New batteries will not achieve full capacity before it has been fully charged and discharged a couple of times.
- i** The battery lifetime is about 500 charging cycles.

Electronics

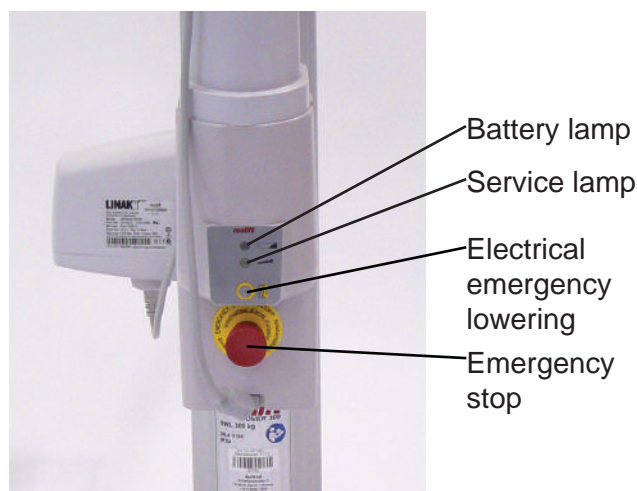

There is a counter implemented in the electronic system of the lifter, registering the number of lifts. This number can be read by using the Molift Service tool, and a service lamp indicates when the lifter needs service consisting of exchange of the lifting motor. See the chapter "Maintenance".

The electronic system has a power save-function which makes the system sleep after a while with no activity. All lights will go out. Activate the system by pushing one of the buttons on the hand control.

If the lifter is run up and down constantly for a longer period, the electronics may be overheated and the lifter will stop. Wait until the lifter is cooled down enough for further use.

- i** Discarded lifters and batteries should be handled as electronic waste and collected separately according to local laws and regulations.

Technical data

Weight, total:

Ex. battery and suspension;	36 kg / 79 lbs
Chassis:	19 kg / 42 lbs
Lifting column:	17 kg / 37 lbs
Battery:	1.6 kg / 3.7 lbs
Suspension:	3.3 kg / 7.3 lbs

Material:

Steel, aluminium and composite plastic

Motor:

Lifting motor/actuator: 24 V DC
Leg spreading motor: 12 V DC

Battery:

Art.no: 1341000
26,4 V NiMH 2,2 Ah,
ATO Fuse 20 A

Battery charger:

Mascot type 2215,
10-22 cells NiCd/NiMH

Protection:

IP24

Number of lifts with fully charged battery:

50 lifts (75 kg / 165 lbs
up/down 50 cm / 20 inches)

Safe Working Load (SWL):

300 kg / 660 lbs

Lifting speed:

27 mm/sek / 1.06 inch/sec

Sound level, max A-weighted sound power level:

$L_{WA} = 63,2$ dB

Operating forces:

Buttons on hand control: 3,4 N

Turning diameter:

1400 mm (55.1 inches)

Measurements:

1322 x 702 x 1388 mm (LxWxH)
52,0 x 27,6 x 54,6 inches (LxWxH)

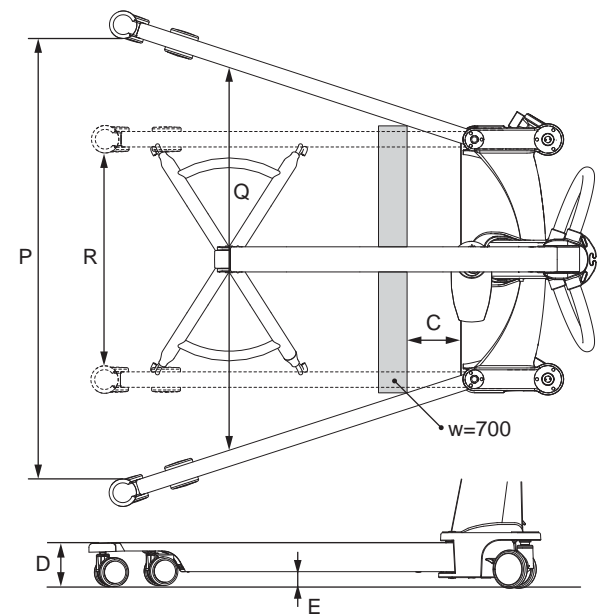
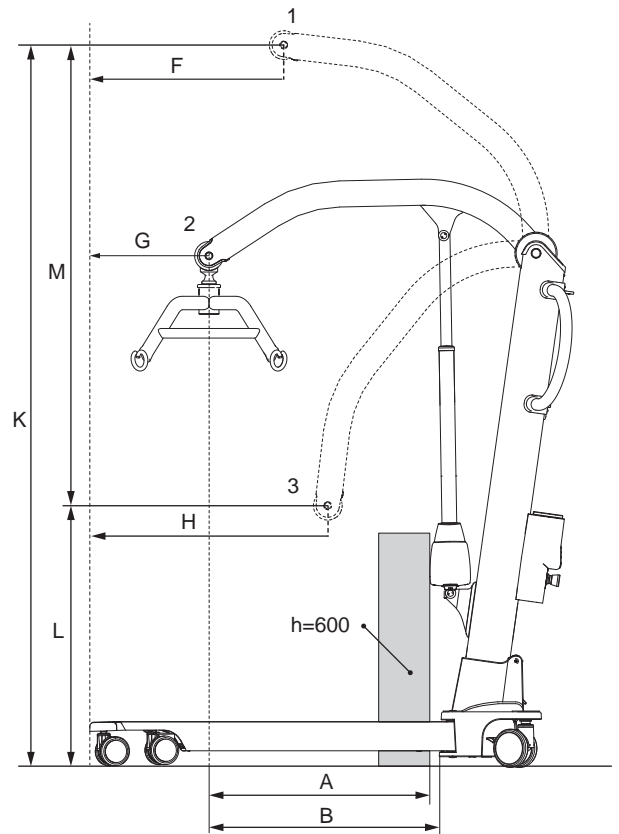

1	Highest position	2070 mm
2	Maximum reach position	1340 mm
3	Lowest position	650 mm
A	Maximum reach at 600 mm	1340 mm
B	Maximum reach from base	630 mm
C	Reach from base with legs spread to 700 mm	180 mm
D	Base height	115 mm
E	Base clearance	43 mm

F	Min. distance from wall to CSP (1)	710 mm
G	Min. distance from wall to CSP (2)	295 mm
H	Min. distance from wall to CSP (3)	640 mm
K	Maximum height of CSP	2070 mm
L	Minimum height of CSP	650 mm
M	Hoisting range	1420 mm
P	Maximum internal width	1065 mm
Q	Internal width at maximum reach	950 mm
R	Minimum internal width	58,5 mm

Labelling

The main label is placed on the bottom of the column.

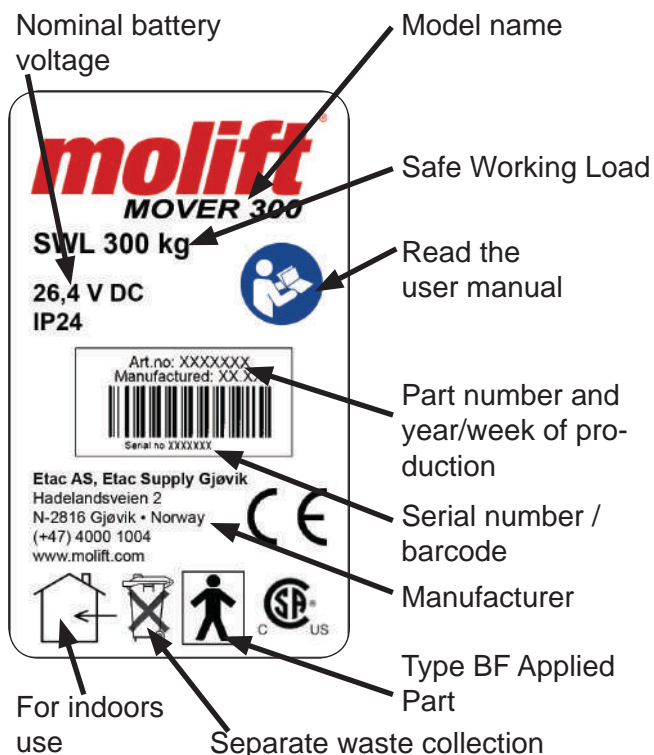

The control label is placed on the right side of the battery holder

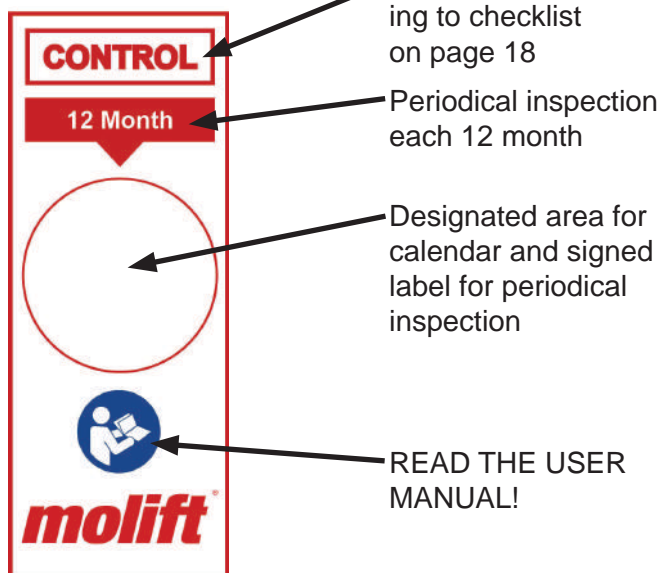

Accessories

Lifting sling

Molift Easy Paediatric Sling

Size	No head support	With head support
XXS	Part no 3005050	Part no 3006050
XS	Part no 3005000	Part no 3006000

Easy Toilet Sling and Basic Bathing Sling for kids, see the tables below, size XXS and XS.

Molift Easy Sling

Size	No head support	With head support
XS	Part no 3025000	Part no 3026000
S	Part no 3025100	Part no 3026100
M	Part no 3025200	Part no 3026200
L	Part no 3025300	Part no 3026300
XL	Part no 3025400	Part no 3026400
XXL	Part no 3025500	Part no 3026500

Molift Basic Sling

Size	No head support	With head support
XXS	Part no 3021050	Part no 3022050
XS	Part no 3021000	Part no 3022000
S	Part no 3021100	Part no 3022100
M	Part no 3021200	Part no 3022200
L	Part no 3021300	Part no 3022300
XL	Part no 3021400	Part no 3022400
XXL	Part no 3021500	Part no 3022500

Molift Basic Bathing Sling

Size	No head support	With head support
XXS	Part no 3023050	Part no 3024050
XS	Part no 3023000	Part no 3024000
S	Part no 3023100	Part no 3024100
M	Part no 3023200	Part no 3024200
L	Part no 3023300	Part no 3024300
XL	Part no 3023400	Part no 3024400
XXL	Part no 3023500	Part no 3024500

Molift Basic Full Sling

Size	With head support
S	Part no 3047010
M	Part no 3074011
L	Part no 3047012

Molift Easy Toilet Sling

Size	No head support	With head support
XXS	Part no 3032050	Part no 3033050
XS	Part no 3032000	Part no 3033000
S	Part no 3032100	Part no 3033100
M	Part no 3032200	Part no 3033200
L	Part no 3032300	Part no 3033300
XL	Part no 3032400	Part no 3033400
XXL	Part no 3032500	Part no 3033500

Molift Easy Toilet Sling Comfort

Size	No head support	Separate head support
XXS	Part no 3016050	Part no 3016055
XS	Part no 3016000	Part no 3016001
S	Part no 3016100	Part no 3016111
M	Part no 3016200	Part no 3016222
L	Part no 3016300	Part no 3016333
XL	Part no 3016400	Part no 3016444
XXL	Part no 3016500	Part no 3016555

Molift Easy Amputee Sling

Size	No head support	With head support
XXS	Part no 3027050	Part no 3028050
XS	Part no 3027000	Part no 3028000
S	Part no 3027100	Part no 3028100
M	Part no 3027200	Part no 3028200
L	Part no 3027300	Part no 3028300
XL	Part no 3027400	Part no 3028400
XXL	Part no 3027500	Part no 3028500

Molift Patient Specific Sling

Size	With head support
S	Part no 3050100
M	Part no 3050200
L	Part no 3050300
XL	Part no 3050400

 Read the user manual that comes with the sling for specific instructions

Bag for slings - Part no 3048000

Sling size guide

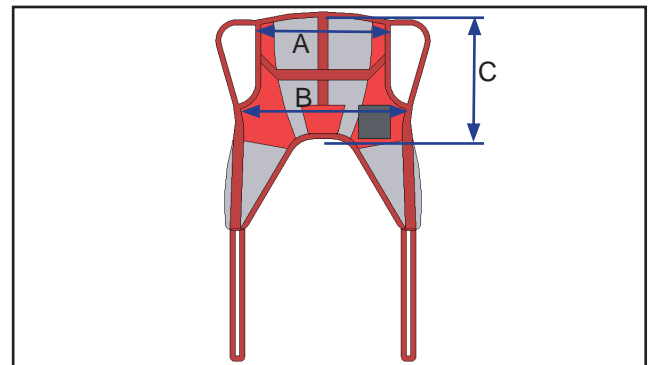

Easy and Basic Slings

Size	Color code	Recomm. weight (Kg)	A (cm)	B (cm)	C (cm)
XXL	White	230-300	86	130	68
XL	Blue	160-240	76	115	66
L	Green	90-160	66	100	64
M	Yellow	45-95	56	85	62
S	Red	25-50	51	75	60
XS	Light blue	17-25	46	65	58
XXS	Pink	12-17	41	55	56

Choice of sling size depends on both user weight and shape/size of user.

Equipment

Quick release suspensions

Steel suspensions

- 4 point steel, Large, size 560x350 mm, Part no: 1430002
- 4 point steel, Medium, size 450x300 mm, Part no: 1430001
- 4 point steel, Small, size 350x240 mm Part no: 1430009
- 2 points steel, Large, size 560 mm, Part no: 1430007
- 2 points steel, Medium, size 450 mm, Part no: 1430006
- 2 points steel, Small, size 350 Part no: 1430008

The suspensions can be used on other Molift lifters with the same quick release. If the suspension is mounted on a lifter with lower SWL, the lowest SWL will apply!

Castor with directional lock

- Part no 1320140

The castor can be changed according to description in Technical Manual by authorized personnel.



This castor has no brake, therefore we recommend to change only one of the castors. Push the red handle down to lock the direction. Release by pulling the handle up.

Integrated charger

- Part no 1340101

The charger can be mounted on the lifter permanently. Park the lifter and connect to a wall socket to charge the battery.

Suspension with scale

- Scale with 4 point steel suspension, Large, Part no: 1431001
- Scale with 4 point steel suspension, Medium, Part no: 1431002



i Read the user manual that comes with the Scale before use.

Change to suspension with scale with quick release as you change to any other suspension.

Molift Stretcher

- Molift Stretcher (excl loops), Part. no: 2150103
- Standard set of lifting loops, Part no: 2150357
- Set of auto strap collector, Part no: 2150356
- Set of Safety belt, Part no: 2150355



The Molift stretcher can be used in combination with all Molift 4-point suspensions on Molift Partner 205.

- Molift Stretcher MR compatible Part no: 2150108
- Only available with Standard set of lifting loops, Part no : 2150357

i Read the operating manual that comes together with the stretcher before use.

Troubleshooting

Faults on lifters that do not function as they should after assembly (page 5) or after the check before use has been completed (page 8), can be localized using the troubleshooting table below.

Symptom	Possible cause/action
The lifting column is wobbly	The lifting column is not correctly positioned in the chassis or the locking handle is not fully locked / <i>verify position of lifting column and locking handle acc. to mounting instructions on page 5.</i>
The lifter moves unevenly on a plane surface	The castors move unevenly because of pile and dust / <i>clean castors as described on page 16.</i>
	Fault in the leg spreading mechanism / <i>contact local representative for service.</i>
The lifter only moves in one direction/ adjustable legs only moves in one direction	Hand control has failed / <i>test with another hand control and change if defective.</i>
	The control electronics has failed / <i>contact local representative for service and use manually emergency lowering, where necessary.</i>
The lifter moves uncontrolled / adjustable legs moves uncontrolled	Short circuit between hand control and lifter / <i>clean hand control plug surfaced with alcohol to remove grease</i>
	Defective hand control / <i>replace hand control / contact local representative for service</i>
	The control electronics has failed / <i>contact local representative for service</i>

Symptom	Possible cause/action
The lifting arm does not move	Emergency stop button is activated / <i>turn button clockwise to reset emergency stop, see p. 9.</i>
	Battery is empty / <i>change to new battery or recharge battery, see page 10.</i>
	The control electronics of the lifter is overheated / <i>Leave lifter to cool down, see page 10</i>
	The lifter is overloaded / <i>make sure the load does not exceed 300 kg, see page 9</i>
	The hand control cable is unplugged / <i>reconnect plug</i>
Battery does not recharge	Hand control has failed / <i>replace hand control / contact local representative for service</i>
	Defective control electronics / <i>contact local representative for service</i>
	Faulty battery / <i>try another battery / replace battery</i>
	Faulty battery charger / <i>try another charger / contact local representative for service</i>

If you have access to more than one lifter, it may be helpful to change parts across lifters to help identify any faults. For instance, if you suspect the fault to be inside the hand control, exchange the hand control with a functional one from another similar lifter to see if the problem is fixed.

If you are not able to solve the fault or problems by yourself using this manual, please contact local authorised service representative. If you do not know whom to contact locally, please contact your dealer or Etac Supply Gjøvik to get help.

Maintenance

Maintenance of the lifter consists of check before use, cleaning, inspection and service. Check the lifter according to the checklist before use on page 7, to reveal faults or errors. In regularly inspections of the lifter, which as a minimum should be monthly inspections and annual (periodic) inspections.

Cleaning



Detergents must be pH-neutral. Do not use solvents or strong liquids - this may damage surfaces on the lifter. For disinfection when needed; use isopropyl alcohol. Avoid abrasive cleaning products.

- Clean surfaces with a damp cloth using an appropriate detergent.
- Remove hair and pile from the castors and verify that the castors rotates without abnormal friction.
- Clean contact and hand control with spirit or similar to remove grease and dirt.
- Regular cleaning is recommended and should be implemented in the suitable cleaning routines.

Monthly inspection

Assemble the lifter before inspection.

- Check the lifter according to the checklist before use on page 7.
- Clean the lifter as described above.
- Verify that the contacts of the hand control and charger is firmly in place, and verify that the cables for the hand control, actuator and charger are intact.
- Run the lifter up and down to verify that it runs normally and without any abnormal noise.
- The lifter must be taken out of service immediately and marked "Out of order", or not taken into service, if faults and/or irregularities are discovered.

Periodic inspection

Etac Supply Gjøvik recommends periodic inspection once a year, alternatively more often if required by local regulations. Use the checklist for periodic inspection on page 18.

Inspection is to be performed by authorized personnel. The owner is responsible to ensure proper logging and written verification of each inspection.

Service

Molift Mover 300 has a LED on the battery holder indicating if the lifter needs service. The LED gives a green light when the lifter is ready for use.

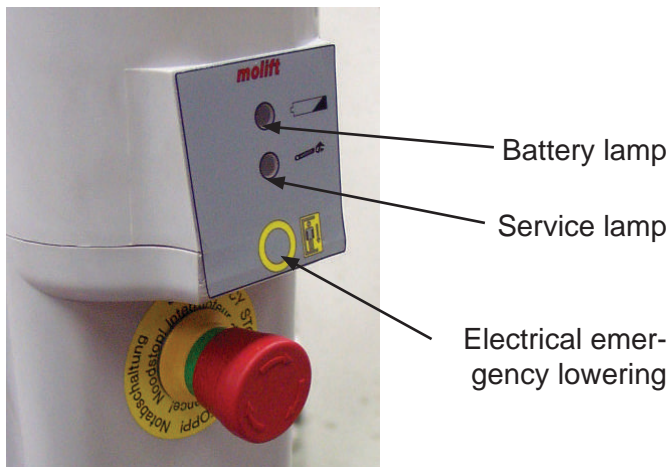

The electronics logs how much the lifter is being used, and the load it is used with. After a given time of usage there will be given a signal that the lifter needs service to the service LED. The LED will first give a yellow light, then red. Take contact with your local service representative and order service. If there is a sound together with the light, it means the lifter needs service immediately.

Service lamp	Status
No light	Power save
Green	Ready for use
Yellow	Order service, lifter still works
Red	Perform service
Red + sound	Perform service immediately

Service consists of replacing the lifting motor and check/replacement of worn or damaged parts. Service and repair shall be performed only by an authorised service representative according to procedures in the technical manual.

The service partner uses the Molift Service Tool to read the data from the lifter, and for logging service and resetting the service LED. The owner is responsible to ensure proper logging and written verification performed by authorised service partner.

A list of spare parts is available on request

Checklist for periodic inspection of Molift Patient Lifters
Molift Mover 300
Revision A – 05/2011

COMPULSORY SAFETY CHECK (annual):

OK	Fault	Corrected	Visual inspection
			Whole lifter checked for damage, cracks and deformation and found to be in good order. (Especially suspension, lifting arm, lifting motor, wheels and all cables).
			Lifter has been correctly assembled and no parts are missing. (Especially column lock, column attachment and suspension).
			Accessories have been checked. See separate form for sling. Battery charger is an accessory. List the accessories checked:.....
			Function checks
			Emergency stop and hand control have been checked and are in working order.
			The lifter has been rolled over the floor (preferably under load) and runs easily and steadily.
			Leg spreading mechanism has been fully extended and retracted (preferably under load), and moves evenly and without noise (stops in correct positions).
			The lifter has been fully raised and lowered (preferably under load) and moves evenly, without noise, and the lifting motor shows no runout.
			Servicing required
			Servicing unnecessary because the servicing lamp is on green and the lifter is under 5 years old.

Completed	Compulsory in case of faults under one of the above points:
	The lifter has been removed from service and clearly marked "OUT OF ORDER".
	Certified personnel have been summoned to carry out repairs and servicing. Name /Tel./ Fax:.....

Completed	Compulsory where lifter has been checked and approved:
	The lifter has passed the safety check and been affixed with the Molift safety check label, duly dated and signed.
	The ticked and signed checklist has been passed to the client and a copy sent to your Molift dealer.

Comments on faults and repairs:.....
.....
.....

Lifter serial no.: other ID no. (if any):.....
Client:
Inspection carried out by: (Block capitals) from.....
Molift certification no. (if any) for inspector/repairer:

The equipment has been tested and is in full working order Yes No

Place: Date: Signature:



Etac AS, Etac Supply Gjøvik
Hadelandsveien 2
2816 Gjøvik
NORWAY
Telephone: + 47 4000 1004

EC DECLARATION OF CONFORMITY

Hereby declare that the following product:

Molift Mover 300

and that the accessoires used only together with this product,
are CE marked and complies with the Council Directive concerning medical devices 93/42/EEC,
and according to this classified as medical equipment class I.

Expiration date: 20th August 2018

Product classification: Hoist for the transfer of disabled people
Product group: Mobile hoist
Usage: Reusable medical device
Sterility: Non
Classification: MDD Class 1

Mover 300 is manufactured in conformity with the following national or
international standards that also might implement a harmonised standard:

ISO10535:2006 Hoists for the transfer of disabled persons - Requirements and test methods
ISO 14971:2007 Medical equipment - Risk analysis
IEC 60601-1, IEC 60601-1-2

Notified body:

Danish Technological Institute
Gregersensvej 3
DK-2630 Taastrup
Denmark
Tel: + 45 7220 2301

NEMKO AS
Gautstadalleen 30
N-0314 OSLO
Norway
Tel: + 47 2296 0342

Title: Site Manager
Name: Knut Martin Frøsaker
Company: Etac AS, Etac Supply Gjøvik

20.08.2013
Date



Signature

Find your distributor
visit Molift.com

molift[®]
a part of Etac